

### TXP / TXC Mask

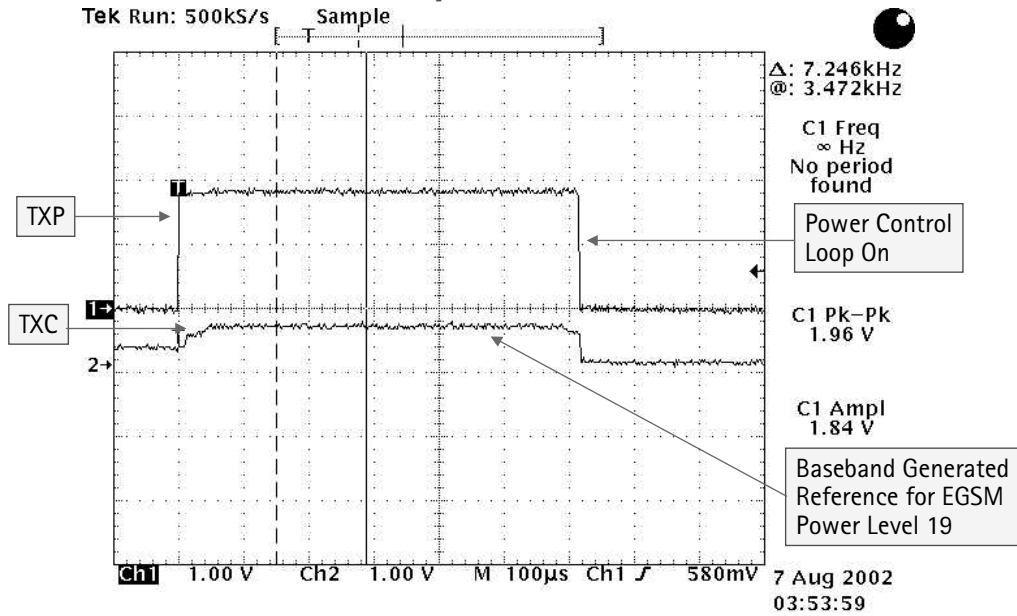

### EGSM TX Can Test Points

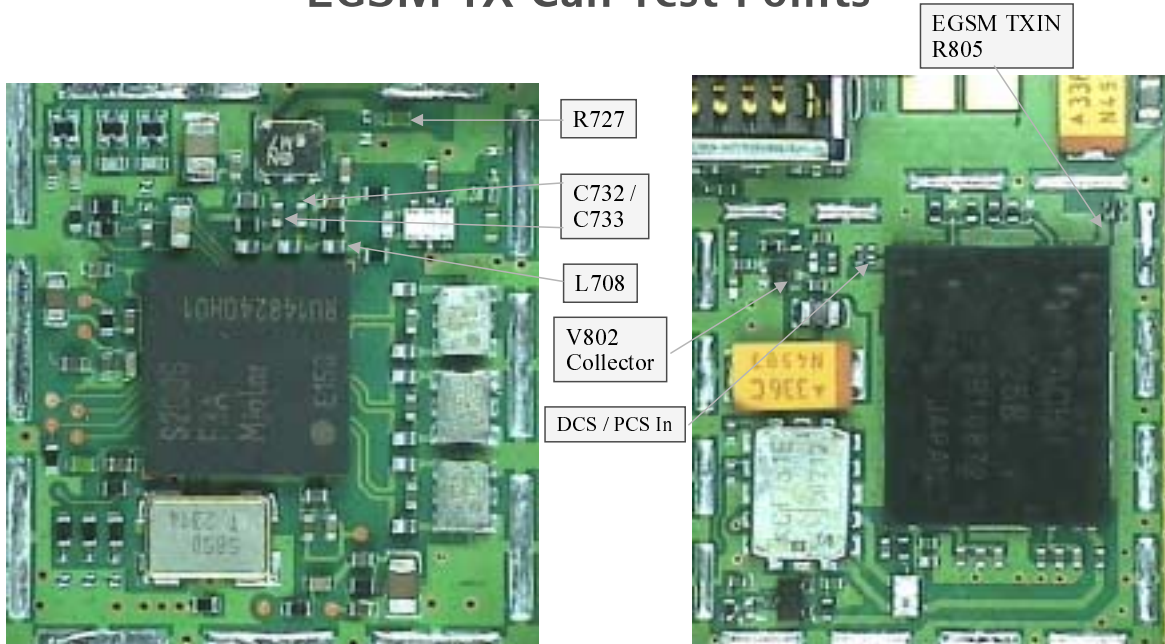

### VTXB\_900 (EGSM V802 Pre-Amp Biasing Waveform)

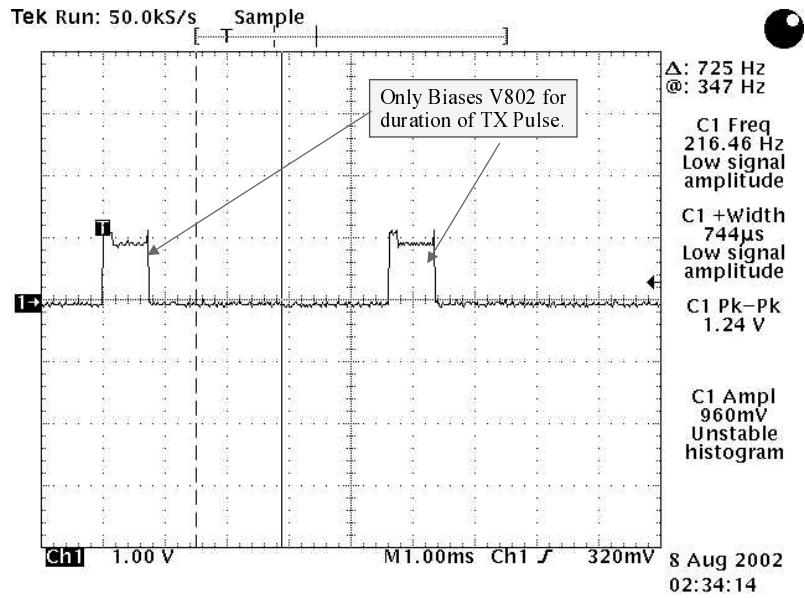

### EGSM Transmit Waveform (Burst, Power Level 19)

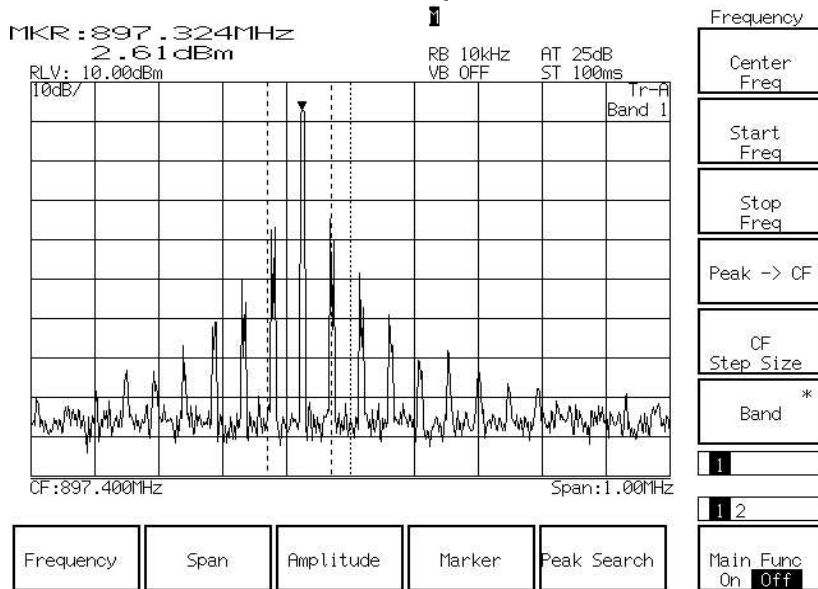

Phone drew 140mA during Burst operation

### EGSM Transmit Waveform (Continuous, Power Level 19)

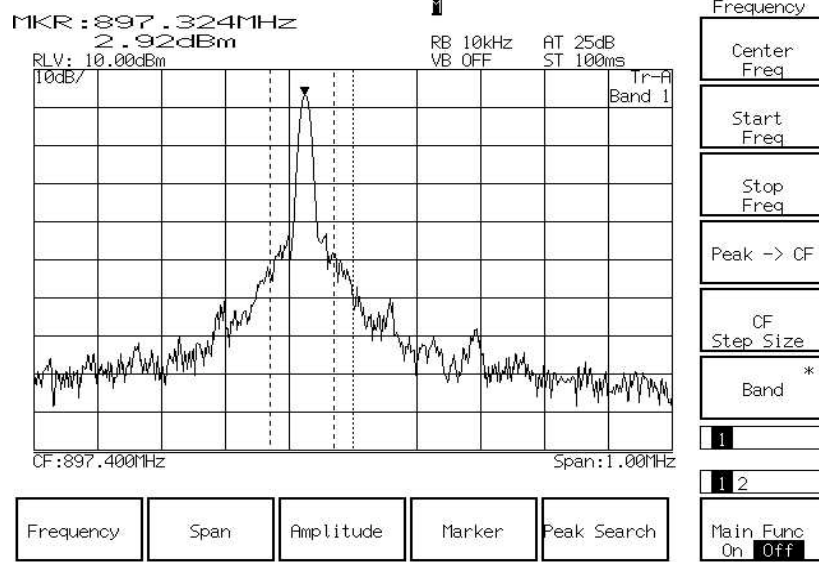

**\*\*Was drawing over 600mA during continuous operation\*\***

### TX Path of the transmitted EGSM900 signal

For easy error tracing it is important to know the signal path of the EGSM900 transmitter. The components can be grouped into blocks and drawn as shown below. Note that the following picture shows both EGSM900 transmitter (bottom) and GSM1800/GSM1900 transmitter (top).



**Antenna Switch (TX/RX switch)**

The antenna Switch works as a diplexer for the RX and TX signals. Moreover, it suppresses the TX harmonics generated by the PA. The antenna switch is controlled by the Mjoelner RF ASIC using the control signals CONT1, CONT2 and CONT3. The following table shows the possible different states.

CONT1 [Volt]	CONT2 [Volt]	CONT3 [Volt]	EGSM Rx	DCS Rx	PCS Rx	EGSM Tx	DCS/PCS Tx
0	0	0	X				
0	0	0		X			
0	0	2.7				X	
0	2.7	0			X		
2.7	0	0					X

**Antenna Switch Test Points**

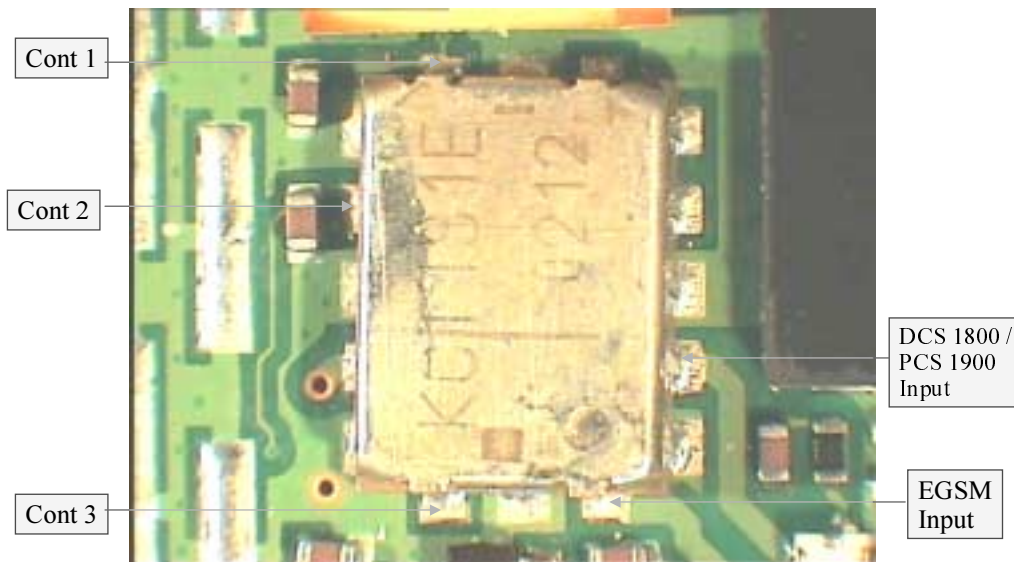

## Antenna Switch Control Line During EGSM Transmission

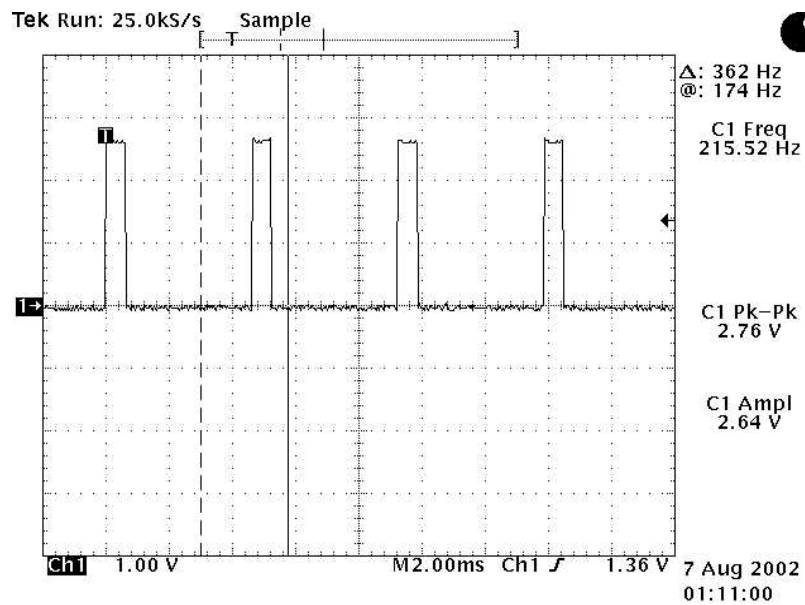

## Transmit Timing

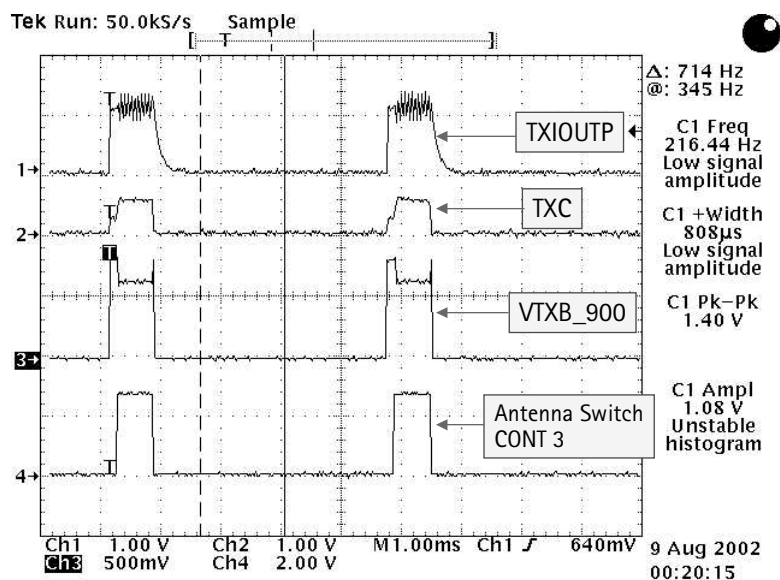

### EGSM Tx fault finding flow chart

The first flow diagram assumes the following:

- Phoenix has been set up as shown in the following screen (the Tx power level may be increased using Phoenix if it makes the Tx pulse easier to see).
- Relevant components have been visually inspected for orientation, placement, etc.
- The transmit signal has been checked with a spectrum analyzer at RF connector, X602 and was found to be too low or non-existent.
- The VCO is running correctly.

- The power amplifier is getting a correct VBATRF supply via L805 & L808.
- Mjoelner's supply voltages VR1A, VR2, VR3, VR4, VR5 & VR7 are all working correctly.

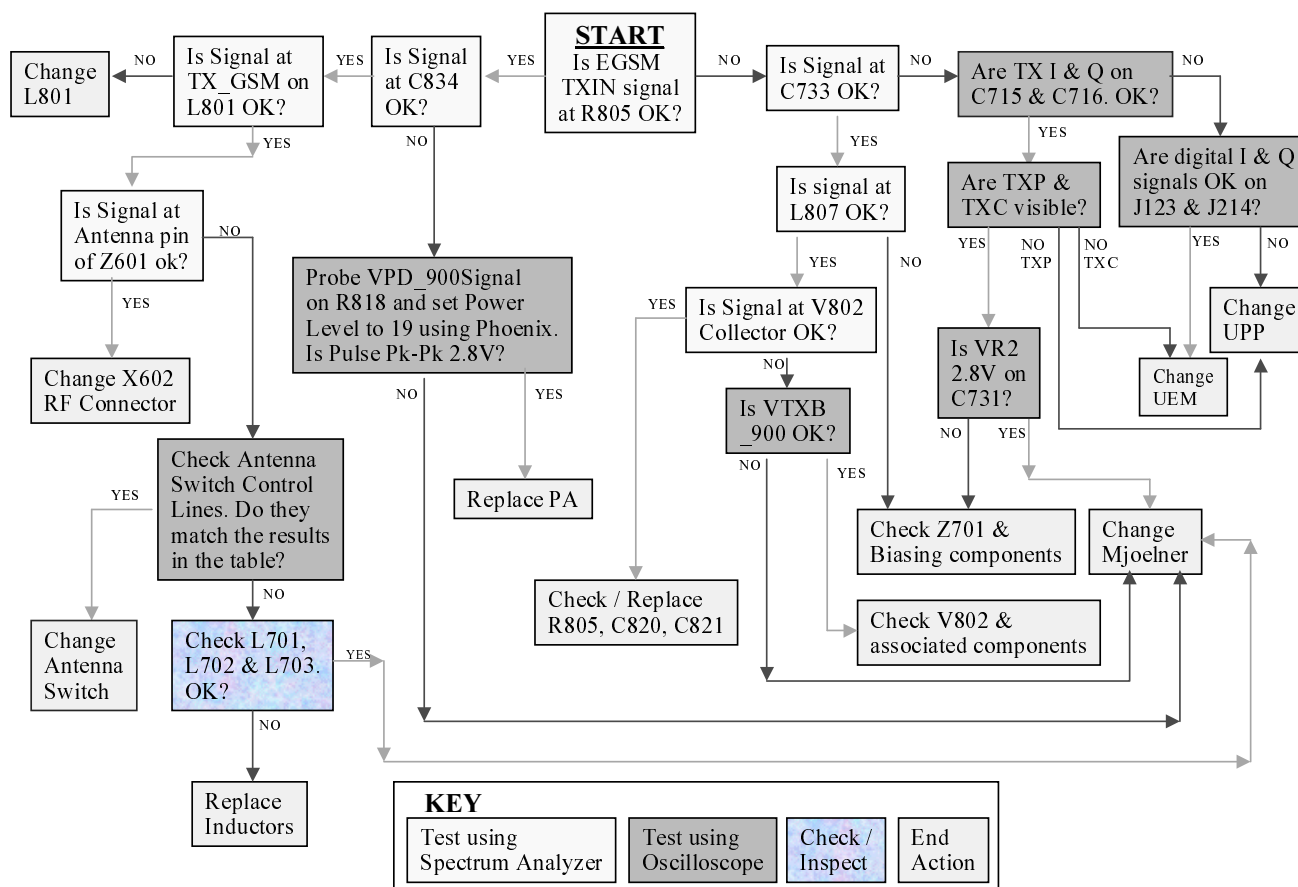

## GSM1800/1900 Transmitter

### General instructions for GSM1800/1900 TX troubleshooting

Apply an RF-cable to the RF-connector to allow the transmitted signal to act as normal. RF-cable should be connected to measurement equipment (GSM Test equipment, Powermeter, Spectrum Analyzer, or similar).

### DCS 1800/PCS 1900 Tx fault finding flow chart

The following diagram assumes the following:

- Phoenix has been set up as shown previously (selecting DCS 1800 in the RF control box).
- Relevant components have been visually inspected for orientation, placement etc.
- The Transmit Signal has been checked with a Spectrum Analyzer at the RF connector, X602 and was found to be low or non-existent.
- The VCO is running correctly.

- The Power Amplifier is getting a correct VBATRF supply via L805 & L808.
- Mjoelner's supply voltages VR1A, VR2, VR3, VR4, VR5 & VR7 are all working correctly.

### Path of the transmitted GSM1800/1900 signal

For easy error tracking it is important to know the signal path of the GSM1800/ GSM1900 transmitter. The components can be grouped into blocks and drawn as shown below. Note that the picture shows both EGSM transmitter (bottom) and GSM1800/ GSM1900 transmitter (top).

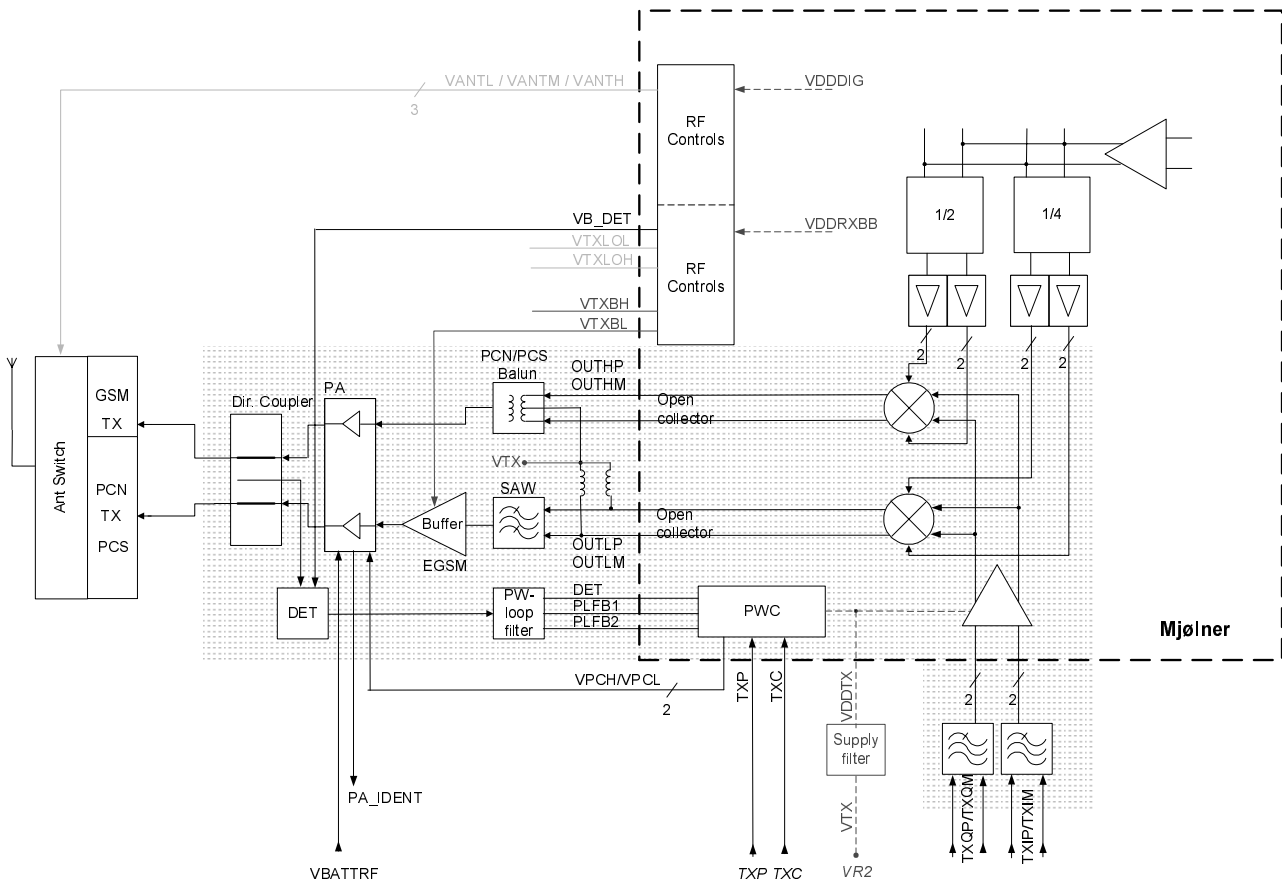

### The path of Mjoelner RF ASIC

The balanced TX signal from base band is coming to Mjoelner RF ASIC. The GSM1900 path includes an common RF modulator for GSM1800 and GSM1900. The BB signal is up-converted with the LO signal corresponding to the wanted TX channel. The GSM1800/ GSM1900 TX output of Mjoelner is a balanced signal.

From the output of Mjoelner the signal is fed through the Balun T701 (Balanced to single ended) and an 3 dB pad to the PA GSM1800/1900 input.



**The path of the PA**

The GSM1800/GSM1900 part of the PA has a maximum output of app. 33dBm. The supply is coming directly from the Battery connectors.

The output is controlled by the power control loop. From the output of the PA the signal goes through the directional coupler (one of the power control loop components) to the Antenna Switch.

**Antenna Switch**

The Antenna Switch works as a diplexer between RX and TX Bands. Moreover, it partly suppresses the harmonics generated by the PA. Mjoelner RF ASIC controls the antenna switch by three voltages CONT1, CONT2 and CONT3. The following table shows the different states.

CONT1 [Volt]	CONT2 [Volt]	CONT3 [Volt]	EGSM Rx	DCS Rx	PCS Rx	EGSM Tx	DCS/PCS Tx
0	0	0	X				
0	0	0		X			
0	0	2.7				X	
0	2.7	0			X		
2.7	0	0					X

**Fault finding chart for GSM1900 transmitter**

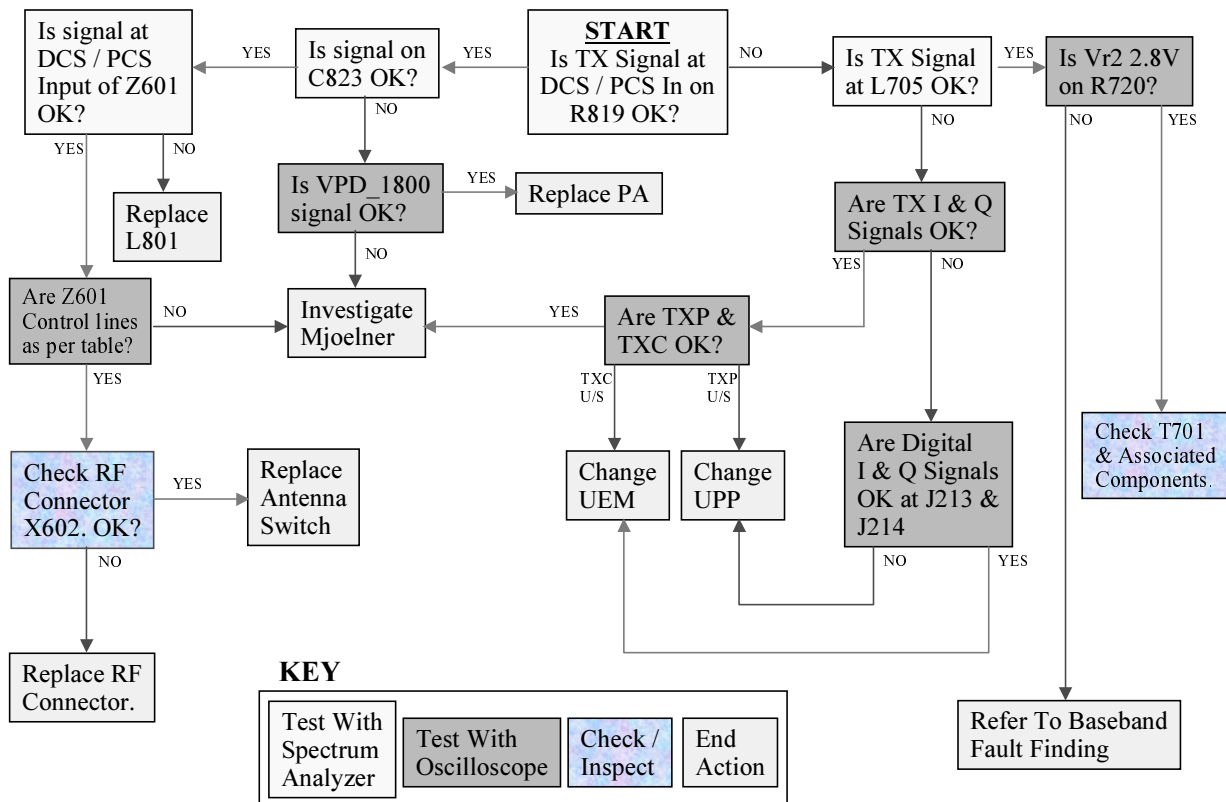

If the Tx output is too high, then it is most likely that there is a problem within the Power Control loop.

Mjoelner is receiving the Reference TXC from Baseband and not getting any feedback from DET to compare with TXC. The result is that Mjoelner drives VDP\_900/VPD\_1800 high to try and increase the power output so that the DET signal is matching TXC. With a break in the Power Control loop, the DET signal never reaches Mjoelner so it assumes that the PA is not outputting enough power so it tries to compensate by increasing the gain.

When checking the Power Control loop, make sure that VBD is pulsing at 2.8V Peak to Peak. Check the DET pulse at Mjoelner input on R706.

This case is the same for EGSM, DCS1800 & DCS1900.

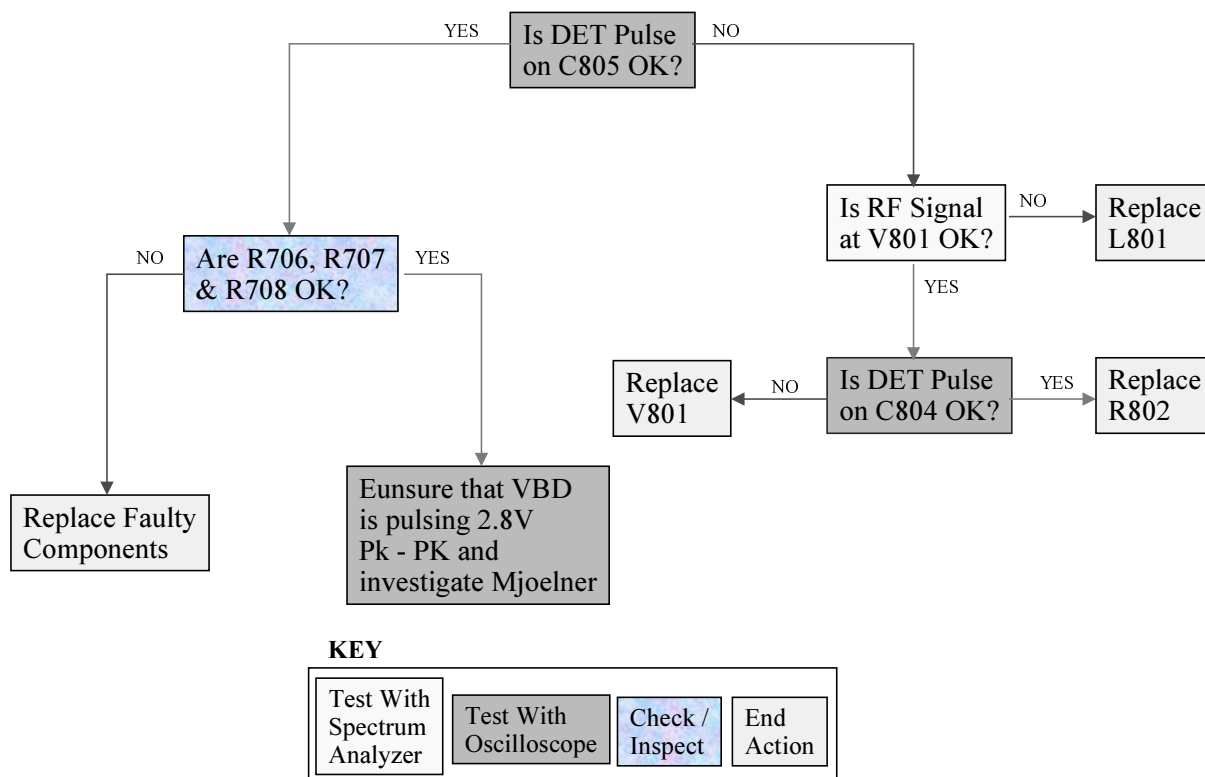

## NHL-8 Synthesiser

There is only one PLL synthesiser generating frequencies for both Rx and Tx for all three bands (EGSM900, GSM1800 and GSM1900). VCO frequency is divided by 2 or by 4 in Mjoelner depending on which band is active.

### General instructions for Synthesiser troubleshooting

Connect the the phone to a PC with DAU-9P cable and dongle and follow these instructions:

#### Start Phoenix Service Software (dongle needed):

Select	Scan Product	Ctrl-R
or	File	Alt-F
	Scan Product	P

Wait until phone information shows in the lower right corner of the screen.

Set operating mode to local mode.

Start RF Control window:

Select	RF	Alt-M
	Tuning	T
	RF Controls	F

Wait until the RF Controls window pops up

Set the synthesiser to the following mode:

Select	Band	GSM 900
	Active unit	RX
	Operation mode	Continuous
	RX/TX Channel	37

The setup should now look like this:

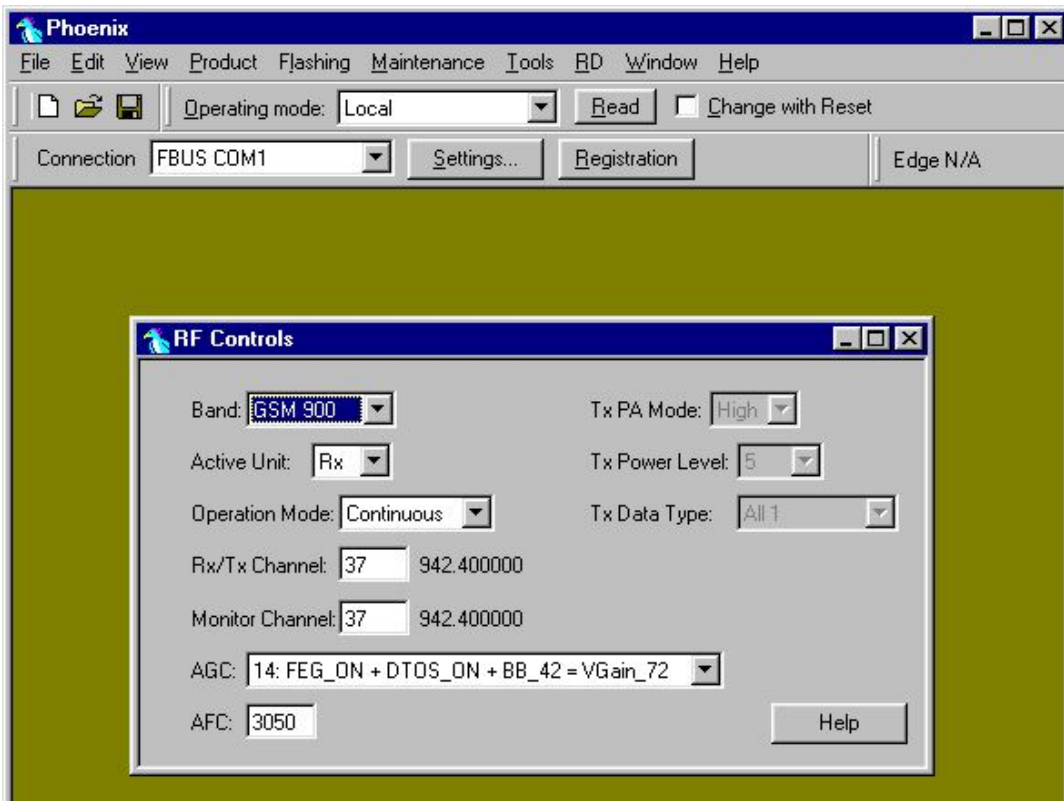

Since VCO chamber is completely shielded, it is not easy to measure frequency of 3769.6MHz at the output of the VCO (G701) using a resistive probe and a spectrum analyzer. It is possible to measure tuning voltage at charge pump output (C710) easily. For  $f_{VCO} = 3769.6\text{MHz}$  the tuning voltage should be  $2.3V_{DC} \dots 2.8V_{DC}$  (Tuning sensitivity of VCO is 240MHz/V typ.).

### PLL Synthesizer Test Points



If this is not the case, then go to Fault finding chart in this document for troubleshooting.

### Mjoelner Can Test Points

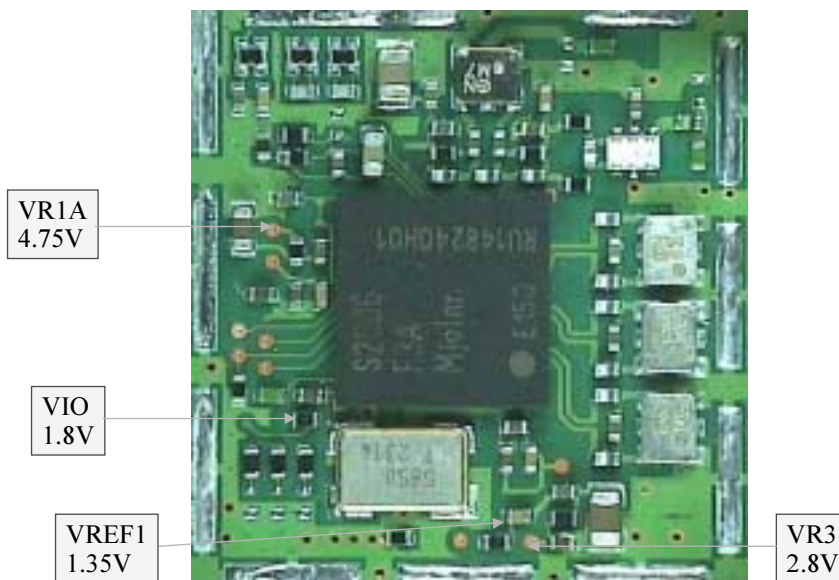

### 26 MHz reference oscillator ( VCXO )

The 26 MHz reference oscillator (VCXO) is part of Mjoelner RF-ASIC (N601). It needs only an external 26 MHz Xtal (B601) as external circuitry.

The reference oscillator has three functions:

- Reference frequency for the PLL synthesiser.
- System clock for BB (RFCIk\_I = 26 MHz).

- 26 MHz Reference clock (LPRFCIk\_I) for Bluetooth Module (N430) via buffer V601.

For an error free initial synchronization, the 26MHz frequency of the VCXO must be accurate enough. Therefore, a **VCXO-calibration (cal)** value is written via the serial Bus into the RefOSCCAL register of Mjoelner and an additional bit in the RefOSCCntl register of the Mjoelner. That is necessary for the rough calibration of the VCXO.

The VCXO is fine tuned by programming the AFC value via the serial bus of Mjoelner. The necessary AFC value is written into the RefOSCAFC register in Mjoelner.

## VCO

The VCO is able to generate frequencies in the range from 3420MHz to 3980MHz when PLL is in function. The frequency of the VCO signal is divided by 2 or by 4 in Mjoelner RF-ASIC. So it is possible to generate the frequency of all channels in EGSM900, GSM1800 and GSM1900 (both RX and TX). Frequency of the VCO is controlled by DC voltage (Vc) coming from the PLL loop filter. Range of Vc when PLL is in function is 0.7V– 3.8V. Typical tuning sensitivity of the VCO is 240MHz/V. Even if PLL is not working (Vc out of range) there is a frequency at the output of the VCO, which is between 3 and 4 GHz (if the VCO itself is ok).

## Fault finding chart for PLL Synthesiser

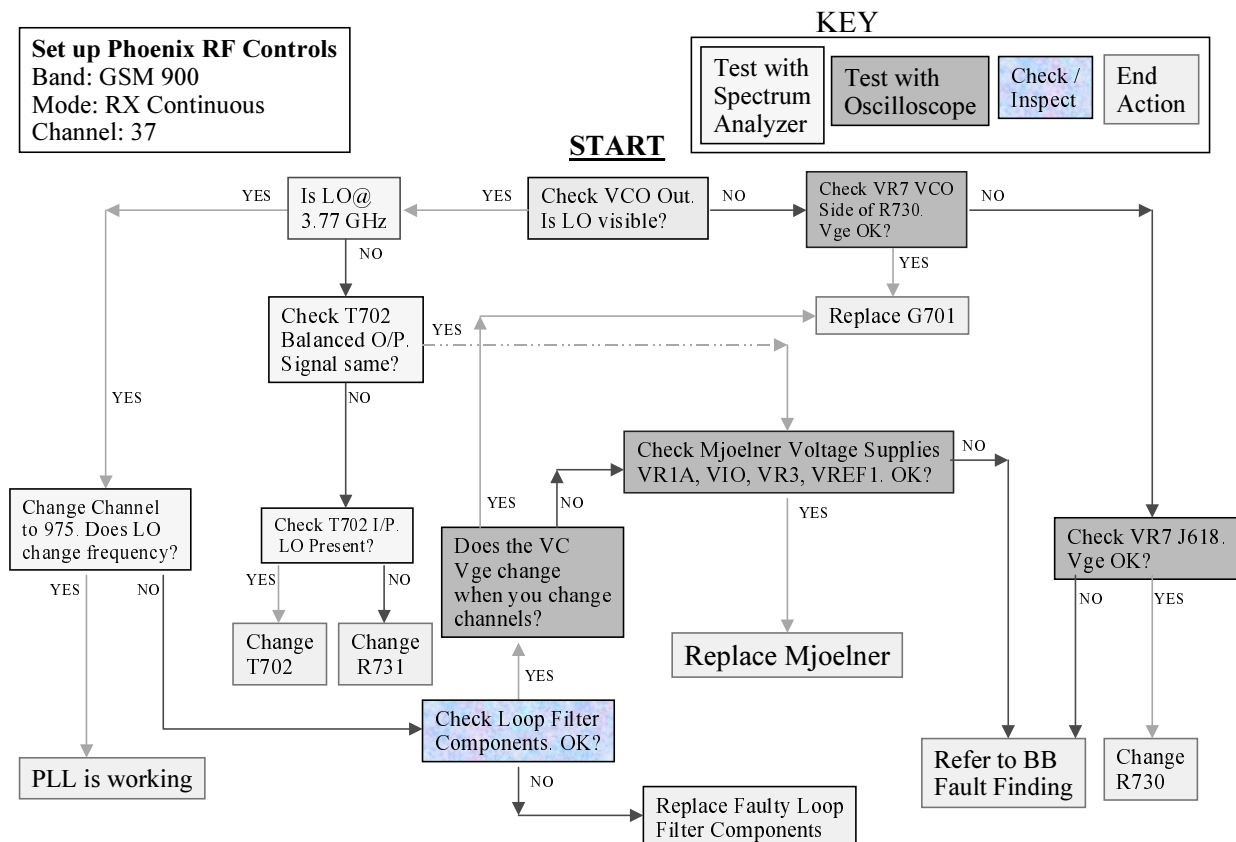

It is important to say that power supply for VCXO ( VR3) is only switched 'OFF' in the so-called 'Deep Sleep Mode' and power supply for VCO (G701 VR7) is switched 'OFF' in so-called 'Sleep Mode'.

PLL Blockdiagram

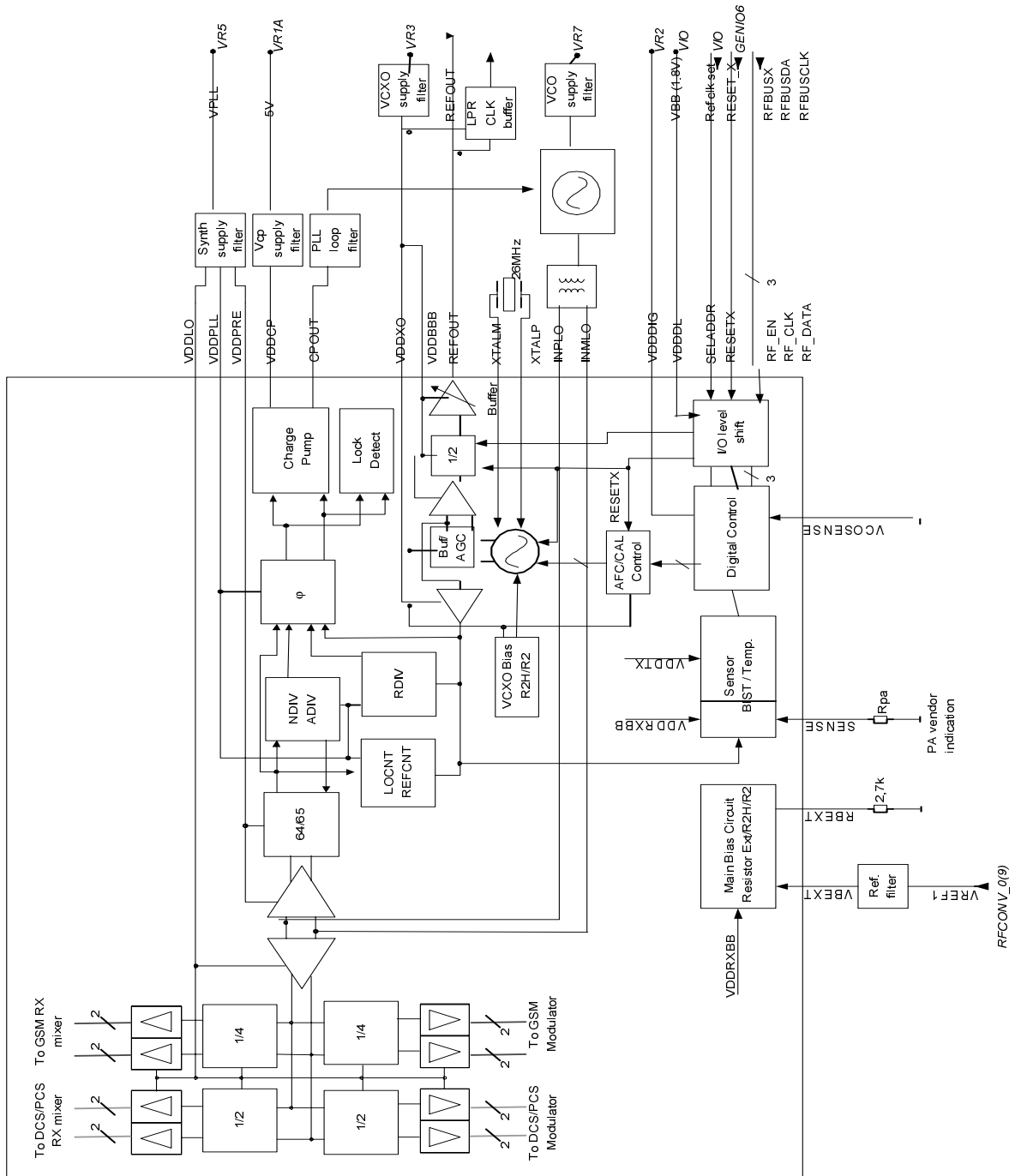

PLL power supply

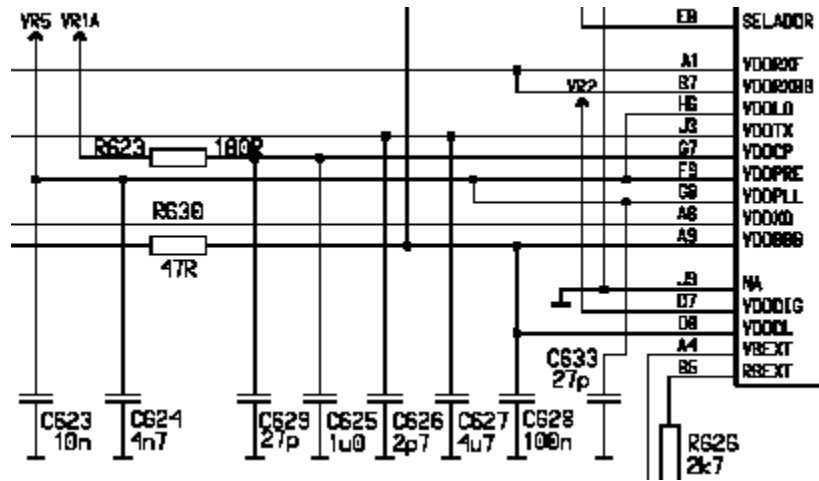

Loop Filter

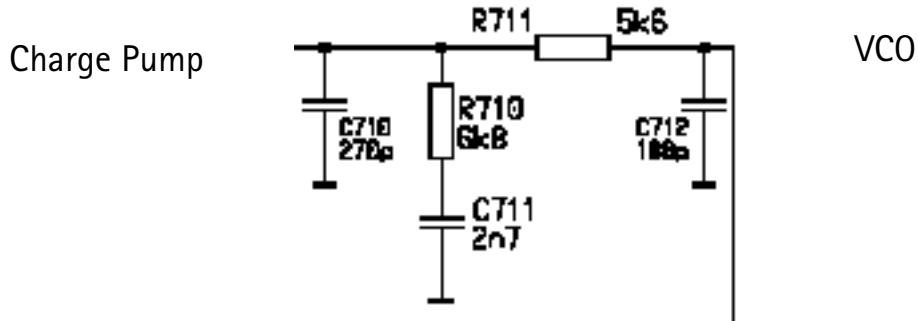

VCO and power supply

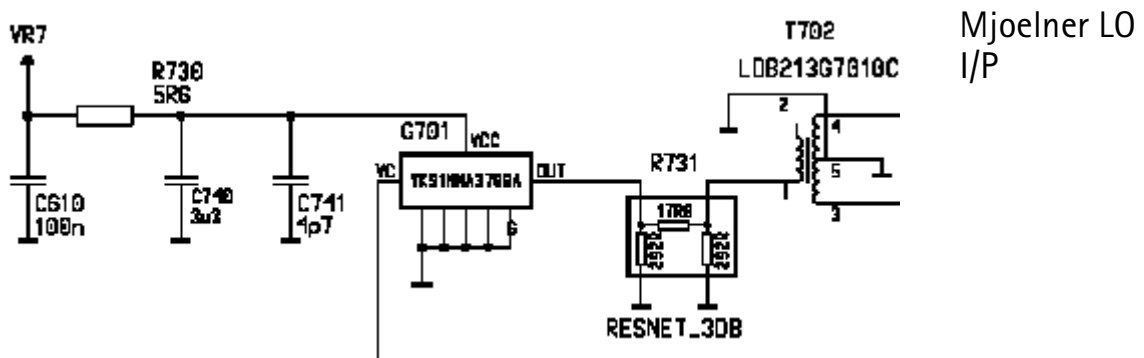

26MHz Bluetooth buffer

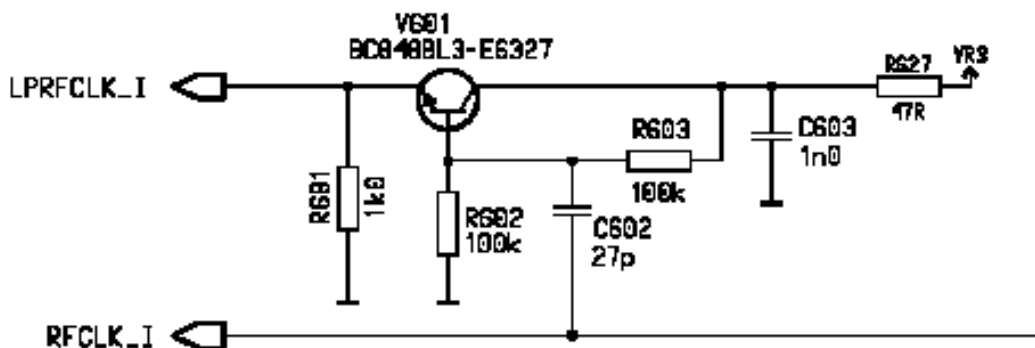



### Frequency lists

#### EGSM900

CH	TX	RX	VCO TX	VCO RX	CH	TX	RX	VCO TX	VCO RX	CH	TX	RX	VCO TX	VCO RX
975	880.2	925.2	3520.8	3700.8	1	890.2	935.2	3560.8	3740.8	63	902.6	947.6	3610.4	3790.4
976	880.4	925.4	3521.6	3701.6	2	890.4	935.4	3561.6	3741.6	64	902.8	947.8	3611.2	3791.2
977	880.6	925.6	3522.4	3702.4	3	890.6	935.6	3562.4	3742.4	65	903.0	948.0	3612.0	3792.0
978	880.8	925.8	3523.2	3703.2	4	890.8	935.8	3563.2	3743.2	66	903.2	948.2	3612.8	3792.8
979	881.0	926.0	3524.0	3704.0	5	891.0	936.0	3564.0	3744.0	67	903.4	948.4	3613.6	3793.6
980	881.2	926.2	3524.8	3704.8	6	891.2	936.2	3564.8	3744.8	68	903.6	948.6	3614.4	3794.4
981	881.4	926.4	3525.6	3705.6	7	891.4	936.4	3565.6	3745.6	69	903.8	948.8	3615.2	3795.2
982	881.6	926.6	3526.4	3706.4	8	891.6	936.6	3566.4	3746.4	70	904.0	949.0	3616.0	3796.0
983	881.8	926.8	3527.2	3707.2	9	891.8	936.8	3567.2	3747.2	71	904.2	949.2	3616.8	3796.8
984	882.0	927.0	3528.0	3708.0	10	892.0	937.0	3568.0	3748.0	72	904.4	949.4	3617.6	3797.6
985	882.2	927.2	3528.8	3708.8	11	892.2	937.2	3568.8	3748.8	73	904.6	949.6	3618.4	3798.4
986	882.4	927.4	3529.6	3709.6	12	892.4	937.4	3569.6	3749.6	74	904.8	949.8	3619.2	3799.2
987	882.6	927.6	3530.4	3710.4	13	892.6	937.6	3570.4	3750.4	75	905.0	950.0	3620.0	3800.0
988	882.8	927.8	3531.2	3711.2	14	892.8	937.8	3571.2	3751.2	76	905.2	950.2	3620.8	3800.8
989	883.0	928.0	3532.0	3712.0	15	893.0	938.0	3572.0	3752.0	77	905.4	950.4	3621.6	3801.6
990	883.2	928.2	3532.8	3712.8	16	893.2	938.2	3572.8	3752.8	78	905.6	950.6	3622.4	3802.4
991	883.4	928.4	3533.6	3713.6	17	893.4	938.4	3573.6	3753.6	79	905.8	950.8	3623.2	3803.2
992	883.6	928.6	3534.4	3714.4	18	893.6	938.6	3574.4	3754.4	80	906.0	951.0	3624.0	3804.0
993	883.8	928.8	3535.2	3715.2	19	893.8	938.8	3575.2	3755.2	81	906.2	951.2	3624.8	3804.8
994	884.0	929.0	3536.0	3716.0	20	894.0	939.0	3576.0	3756.0	82	906.4	951.4	3625.6	3805.6
995	884.2	929.2	3536.8	3716.8	21	894.2	939.2	3576.8	3756.8	83	906.6	951.6	3626.4	3806.4
996	884.4	929.4	3537.6	3717.6	22	894.4	939.4	3577.6	3757.6	84	906.8	951.8	3627.2	3807.2
997	884.6	929.6	3538.4	3718.4	23	894.6	939.6	3578.4	3758.4	85	907.0	952.0	3628.0	3808.0
998	884.8	929.8	3539.2	3719.2	24	894.8	939.8	3579.2	3759.2	86	907.2	952.2	3628.8	3808.8
999	885.0	930.0	3540.0	3720.0	25	895.0	940.0	3580.0	3760.0	87	907.4	952.4	3629.6	3809.6
1000	885.2	930.2	3540.8	3720.8	26	895.2	940.2	3580.8	3760.8	88	907.6	952.6	3630.4	3810.4
1001	885.4	930.4	3541.6	3721.6	27	895.4	940.4	3581.6	3761.6	89	907.8	952.8	3631.2	3811.2
1002	885.6	930.6	3542.4	3722.4	28	895.6	940.6	3582.4	3762.4	90	908.0	953.0	3632.0	3812.0
1003	885.8	930.8	3543.2	3723.2	29	895.8	940.8	3583.2	3763.2	91	908.2	953.2	3632.8	3812.8
1004	886.0	931.0	3544.0	3724.0	30	896.0	941.0	3584.0	3764.0	92	908.4	953.4	3633.6	3813.6
1005	886.2	931.2	3544.8	3724.8	31	896.2	941.2	3584.8	3764.8	93	908.6	953.6	3634.4	3814.4
1006	886.4	931.4	3545.6	3725.6	32	896.4	941.4	3585.6	3765.6	94	908.8	953.8	3635.2	3815.2
1007	886.6	931.6	3546.4	3726.4	33	896.6	941.6	3586.4	3766.4	95	909.0	954.0	3636.0	3816.0
1008	886.8	931.8	3547.2	3727.2	34	896.8	941.8	3587.2	3767.2	96	909.2	954.2	3636.8	3816.8
1009	887.0	932.0	3548.0	3728.0	35	897.0	942.0	3588.0	3768.0	97	909.4	954.4	3637.6	3817.6
1010	887.2	932.2	3548.8	3728.8	36	897.2	942.2	3588.8	3768.8	98	909.6	954.6	3638.4	3818.4
1011	887.4	932.4	3549.6	3729.6	37	897.4	942.4	3589.6	3769.6	99	909.8	954.8	3639.2	3819.2
1012	887.6	932.6	3550.4	3730.4	38	897.6	942.6	3590.4	3770.4	100	910.0	955.0	3640.0	3820.0
1013	887.8	932.8	3551.2	3731.2	39	897.8	942.8	3591.2	3771.2	101	910.2	955.2	3640.8	3820.8
1014	888.0	933.0	3552.0	3732.0	40	898.0	943.0	3592.0	3772.0	102	910.4	955.4	3641.6	3821.6
1015	888.2	933.2	3552.8	3732.8	41	898.2	943.2	3592.8	3772.8	103	910.6	955.6	3642.4	3822.4
1016	888.4	933.4	3553.6	3733.6	42	898.4	943.4	3593.6	3773.6	104	910.8	955.8	3643.2	3823.2
1017	888.6	933.6	3554.4	3734.4	43	898.6	943.6	3594.4	3774.4	105	911.0	956.0	3644.0	3824.0
1018	888.8	933.8	3555.2	3735.2	44	898.8	943.8	3595.2	3775.2	106	911.2	956.2	3644.8	3824.8
1019	889.0	934.0	3556.0	3736.0	45	899.0	944.0	3596.0	3776.0	107	911.4	956.4	3645.6	3825.6
1020	889.2	934.2	3556.8	3736.8	46	899.2	944.2	3596.8	3776.8	108	911.6	956.6	3646.4	3826.4
1021	889.4	934.4	3557.6	3737.6	47	899.4	944.4	3597.6	3777.6	109	911.8	956.8	3647.2	3827.2
1022	889.6	934.6	3558.4	3738.4	48	899.6	944.6	3598.4	3778.4	110	912.0	957.0	3648.0	3828.0
1023	889.8	934.8	3559.2	3739.2	49	899.8	944.8	3599.2	3779.2	111	912.2	957.2	3648.8	3828.8
0	890.0	935.0	3560.0	3740.0	50	900.0	945.0	3600.0	3780.0	112	912.4	957.4	3649.6	3829.6
					51	900.2	945.2	3600.8	3780.8	113	912.6	957.6	3650.4	3830.4
					52	900.4	945.4	3601.6	3781.6	114	912.8	957.8	3651.2	3831.2
					53	900.6	945.6	3602.4	3782.4	115	913.0	958.0	3652.0	3832.0
					54	900.8	945.8	3603.2	3783.2	116	913.2	958.2	3652.8	3832.8
					55	901.0	946.0	3604.0	3784.0	117	913.4	958.4	3653.6	3833.6
					56	901.2	946.2	3604.8	3784.8	118	913.6	958.6	3654.4	3834.4
					57	901.4	946.4	3605.6	3785.6	119	913.8	958.8	3655.2	3835.2
					58	901.6	946.6	3606.4	3786.4	120	914.0	959.0	3656.0	3836.0
					59	901.8	946.8	3607.2	3787.2	121	914.2	959.2	3656.8	3836.8
					60	902.0	947.0	3608.0	3788.0	122	914.4	959.4	3657.6	3837.6
					61	902.2	947.2	3608.8	3788.8	123	914.6	959.6	3658.4	3838.4
					62	902.4	947.4	3609.6	3789.6	124	914.8	959.8	3659.2	3839.2

GSM1800

CH	TX	RX	VCO TX	VCO RX	CH	TX	RX	VCO TX	VCO RX	CH	TX	RX	VCO TX	VCO RX	CH	TX	RX	VCO TX	VCO RX
512	1710.2	1805.2	3420.4	3610.4	606	1729.0	1824.0	3458.0	3648.0	700	1747.8	1842.8	3495.6	3685.6	794	1766.6	1861.6	3533.2	3723.2
513	1710.4	1805.4	3420.8	3610.8	607	1729.2	1824.2	3458.4	3648.4	701	1748.0	1843.0	3496.0	3686.0	795	1766.8	1861.8	3533.6	3723.6
514	1710.6	1805.6	3421.2	3611.2	608	1729.4	1824.4	3458.8	3648.8	702	1748.2	1843.2	3496.4	3686.4	796	1767.0	1862.0	3534.0	3724.0
515	1710.8	1805.8	3421.6	3611.6	609	1729.6	1824.6	3459.2	3649.2	703	1748.4	1843.4	3496.8	3686.8	797	1767.2	1862.2	3534.4	3724.4
516	1711.0	1806.0	3422.0	3612.0	610	1729.8	1824.8	3459.6	3649.6	704	1748.6	1843.6	3497.2	3687.2	798	1767.4	1862.4	3534.8	3724.8
517	1711.2	1806.2	3422.4	3612.4	611	1730.0	1825.0	3460.0	3650.0	705	1748.8	1843.8	3497.6	3687.6	799	1767.6	1862.6	3535.2	3725.2
518	1711.4	1806.4	3422.8	3612.8	612	1730.2	1825.2	3460.4	3650.4	706	1749.0	1844.0	3498.0	3688.0	800	1767.8	1862.8	3535.6	3725.6
519	1711.6	1806.6	3423.2	3613.2	613	1730.4	1825.4	3460.8	3650.8	707	1749.2	1844.2	3498.4	3688.4	801	1768.0	1863.0	3536.0	3726.0
520	1711.8	1806.8	3423.6	3613.6	614	1730.6	1825.6	3461.2	3651.2	708	1749.4	1844.4	3498.8	3688.8	802	1768.2	1863.2	3536.4	3726.4
521	1712.0	1807.0	3424.0	3614.0	615	1730.8	1825.8	3461.6	3651.6	709	1749.6	1844.6	3499.2	3689.2	803	1768.4	1863.4	3536.8	3726.8
522	1712.2	1807.2	3424.4	3614.4	616	1731.0	1826.0	3462.0	3652.0	710	1749.8	1844.8	3499.6	3689.6	804	1768.6	1863.6	3537.2	3727.2
523	1712.4	1807.4	3424.8	3614.8	617	1731.2	1826.2	3462.4	3652.4	711	1750.0	1845.0	3500.0	3690.0	805	1768.8	1863.8	3537.6	3727.6
524	1712.6	1807.6	3425.2	3615.2	618	1731.4	1826.4	3462.8	3652.8	712	1750.2	1845.2	3500.4	3690.4	806	1769.0	1864.0	3538.0	3728.0
525	1712.8	1807.8	3425.6	3615.6	619	1731.6	1826.6	3463.2	3653.2	713	1750.4	1845.4	3500.8	3690.8	807	1769.2	1864.2	3538.4	3728.4
526	1713.0	1808.0	3426.0	3616.0	620	1731.8	1826.8	3463.6	3653.6	714	1750.6	1845.6	3501.2	3691.2	808	1769.4	1864.4	3538.8	3728.8
527	1713.2	1808.2	3426.4	3616.4	621	1732.0	1827.0	3464.0	3654.0	715	1750.8	1845.8	3501.6	3691.6	809	1769.6	1864.6	3539.2	3729.2
528	1713.4	1808.4	3426.8	3616.8	622	1732.2	1827.2	3464.4	3654.4	716	1751.0	1846.0	3502.0	3692.0	810	1769.8	1864.8	3539.6	3729.6
529	1713.6	1808.6	3427.2	3617.2	623	1732.4	1827.4	3464.8	3654.8	717	1751.2	1846.2	3502.4	3692.4	811	1770.0	1865.0	3540.0	3730.0
530	1713.8	1808.8	3427.6	3617.6	624	1732.6	1827.6	3465.2	3655.2	718	1751.4	1846.4	3502.8	3692.8	812	1770.2	1865.2	3540.4	3730.4
531	1714.0	1809.0	3428.0	3618.0	625	1732.8	1827.8	3465.6	3655.6	719	1751.6	1846.6	3503.2	3693.2	813	1770.4	1865.4	3540.8	3730.8
532	1714.2	1809.2	3428.4	3618.4	626	1733.0	1828.0	3466.0	3656.0	720	1751.8	1846.8	3503.6	3693.6	814	1770.6	1865.6	3541.2	3731.2
533	1714.4	1809.4	3428.8	3618.8	627	1733.2	1828.2	3466.4	3656.4	721	1752.0	1847.0	3504.0	3694.0	815	1770.8	1865.8	3541.6	3731.6
534	1714.6	1809.6	3429.2	3619.2	628	1733.4	1828.4	3466.8	3656.8	722	1752.2	1847.2	3504.4	3694.4	816	1771.0	1866.0	3542.0	3732.0
535	1714.8	1809.8	3429.6	3619.6	629	1733.6	1828.6	3467.2	3657.2	723	1752.4	1847.4	3504.8	3694.8	817	1771.2	1866.2	3542.4	3732.4
536	1715.0	1810.0	3430.0	3620.0	630	1733.8	1828.8	3467.6	3657.6	724	1752.6	1847.6	3505.2	3695.2	818	1771.4	1866.4	3542.8	3732.8
537	1715.2	1810.2	3430.4	3620.4	631	1734.0	1829.0	3468.0	3658.0	725	1752.8	1847.8	3505.6	3695.6	819	1771.6	1866.6	3543.2	3733.2
538	1715.4	1810.4	3430.8	3620.8	632	1734.2	1829.2	3468.4	3658.4	726	1753.0	1848.0	3506.0	3696.0	820	1771.8	1866.8	3543.6	3733.6
539	1715.6	1810.6	3431.2	3621.2	633	1734.4	1829.4	3468.8	3658.8	727	1753.2	1848.2	3506.4	3696.4	821	1772.0	1867.0	3544.0	3734.0
540	1715.8	1810.8	3431.6	3621.6	634	1734.6	1829.6	3469.2	3659.2	728	1753.4	1848.4	3506.8	3696.8	822	1772.2	1867.2	3544.4	3734.4
541	1716.0	1811.0	3432.0	3622.0	635	1734.8	1829.8	3469.6	3659.6	729	1753.6	1848.6	3507.2	3697.2	823	1772.4	1867.4	3544.8	3734.8
542	1716.2	1811.2	3432.4	3622.4	636	1735.0	1830.0	3470.0	3660.0	730	1753.8	1848.8	3507.6	3697.6	824	1772.6	1867.6	3545.2	3735.2
543	1716.4	1811.4	3432.8	3622.8	637	1735.2	1830.2	3470.4	3660.4	731	1754.0	1849.0	3508.0	3698.0	825	1772.8	1867.8	3545.6	3735.6
544	1716.6	1811.6	3433.2	3623.2	638	1735.4	1830.4	3470.8	3660.8	732	1754.2	1849.2	3508.4	3698.4	826	1773.0	1868.0	3546.0	3736.0
545	1716.8	1811.8	3433.6	3623.6	639	1735.6	1830.6	3471.2	3661.2	733	1754.4	1849.4	3508.8	3698.8	827	1773.2	1868.2	3546.4	3736.4
546	1717.0	1812.0	3434.0	3624.0	640	1735.8	1830.8	3471.6	3661.6	734	1754.6	1849.6	3509.2	3699.2	828	1773.4	1868.4	3546.8	3736.8
547	1717.2	1812.2	3434.4	3624.4	641	1736.0	1831.0	3472.0	3662.0	735	1754.8	1849.8	3509.6	3699.6	829	1773.6	1868.6	3547.2	3737.2
548	1717.4	1812.4	3434.8	3624.8	642	1736.2	1831.2	3472.4	3662.4	736	1755.0	1850.0	3510.0	3700.0	830	1773.8	1868.8	3547.6	3737.6
549	1717.6	1812.6	3435.2	3625.2	643	1736.4	1831.4	3472.8	3662.8	737	1755.2	1850.2	3510.4	3700.4	831	1774.0	1869.0	3548.0	3738.0
550	1717.8	1812.8	3435.6	3625.6	644	1736.6	1831.6	3473.2	3663.2	738	1755.4	1850.4	3510.8	3700.8	832	1774.2	1869.2	3548.4	3738.4
551	1718.0	1813.0	3436.0	3626.0	645	1736.8	1831.8	3473.6	3663.6	739	1755.6	1850.6	3511.2	3701.2	833	1774.4	1869.4	3548.8	3738.8
552	1718.2	1813.2	3436.4	3626.4	646	1737.0	1832.0	3474.0	3664.0	740	1755.8	1850.8	3511.6	3701.6	834	1774.6	1869.6	3549.2	3739.2
553	1718.4	1813.4	3436.8	3626.8	647	1737.2	1832.2	3474.4	3664.4	741	1756.0	1851.0	3512.0	3702.0	835	1774.8	1869.8	3549.6	3739.6
554	1718.6	1813.6	3437.2	3627.2	648	1737.4	1832.4	3474.8	3664.8	742	1756.2	1851.2	3512.4	3702.4	836	1775.0	1870.0	3550.0	3740.0
555	1718.8	1813.8	3437.6	3627.6	649	1737.6	1832.6	3475.2	3665.2	743	1756.4	1851.4	3512.8	3702.8	837	1775.2	1870.2	3550.4	3740.4
556	1719.0	1814.0	3438.0	3628.0	650	1737.8	1832.8	3475.6	3665.6	744	1756.6	1851.6	3513.2	3703.2	838	1775.4	1870.4	3550.8	3740.8
557	1719.2	1814.2	3438.4	3628.4	651	1738.0	1833.0	3476.0	3666.0	745	1756.8	1851.8	3513.6	3703.6	839	1775.6	1870.6	3551.2	3741.2
558	1719.4	1814.4	3438.8	3628.8	652	1738.2	1833.2	3476.4	3666.4	746	1757.0	1852.0	3514.0	3704.0	840	1775.8	1870.8	3551.6	3741.6
559	1719.6	1814.6	3439.2	3629.2	653	1738.4	1833.4	3476.8	3666.8	747	1757.2	1852.2	3514.4	3704.4	841	1776.0	1871.0	3552.0	3742.0
560	1719.8	1814.8	3439.6	3629.6	654	1738.6	1833.6	3477.2	3667.2	748	1757.4	1852.4	3514.8	3704.8	842	1776.2	1871.2	3552.4	3742.4
561	1720.0	1815.0	3440.0	3630.0	655	1738.8	1833.8	3477.6	3667.6	749	1757.6	1852.6	3515.2	3705.2	843	1776.4	1871.4	3552.8	3742.8
562	1720.2	1815.2	3440.4	3630.4	656	1739.0	1834.0	3478.0	3668.0	750	1757.8	1852.8	3515.6	3705.6	844	1776.6	1871.6	3553.2	3743.2
563	1720.4	1815.4	3440.8	3630.8	657	1739.2	1834.2	3478.4	3668.4	751	1758.0	1853.0	3516.0	3706.0	845	1776.8	1871.8	3553.6	3743.6
564	1720.6	1815.6	3441.2	3631.2	658	1739.4	1834.4	3478.8	3668.8	752	1758.2	1853.2	3516.4	3706.4	846	1777.0	1872.0	3554.0	3744.0
565	1720.8	1815.8	3441.6	3631.6	659	1739.6	1834.6	3479.2	3669.2	753	1758.4	1853.4	3516.8	3706.8	847	1777.2	1872.2	3554.4	3744.4
566	1721.0	1816.0	3442.0	3632.0	660	1739.8	1834.8	3479.6	3669.6	754	1758.6	1853.6	3517.2	3707.2	848	1777.4	1872.4	3554.8	3744.8
567	1721.2	1816.2	3442.4	3632.4	661	1740.0	1835.0	3480.0	3670.0	755	1758.8	1853.8	3517.6	3707.6	849	1777.6	1872.6	3555.2	3745.2
568	1721.4	1816.4	3442.8	3632.8	662	1740.2	1835.2	3480.4	367										

GSM1900

CH	TX	RX	VCO TX	VCO RX	CH	TX	RX	VCO TX	VCO RX	CH	TX	RX	VCO TX	VCO RX	CH	TX	RX	VCO TX	VCO RX
512	1850.2	1930.2	3700.4	3860.4	606	1869.0	1949.0	3738.0	3898.0	700	1887.8	1967.8	3775.6	3935.6	794	1906.6	1986.6	3813.2	3973.2
513	1850.4	1930.4	3700.8	3860.8	607	1869.2	1949.2	3738.4	3898.4	701	1888.0	1968.0	3776.0	3936.0	795	1906.8	1986.8	3813.6	3973.6
514	1850.6	1930.6	3701.2	3861.2	608	1869.4	1949.4	3738.8	3898.8	702	1888.2	1968.2	3776.4	3936.4	796	1907.0	1987.0	3814.0	3974.0
515	1850.8	1930.8	3701.6	3861.6	609	1869.6	1949.6	3739.2	3899.2	703	1888.4	1968.4	3776.8	3936.8	797	1907.2	1987.2	3814.4	3974.4
516	1851.0	1931.0	3702.0	3862.0	610	1869.8	1949.8	3739.6	3899.6	704	1888.6	1968.6	3777.2	3937.2	798	1907.4	1987.4	3814.8	3974.8
517	1851.2	1931.2	3702.4	3862.4	611	1870.0	1950.0	3740.0	3900.0	705	1888.8	1968.8	3777.6	3937.6	799	1907.6	1987.6	3815.2	3975.2
518	1851.4	1931.4	3702.8	3862.8	612	1870.2	1950.2	3740.4	3900.4	706	1889.0	1969.0	3778.0	3938.0	800	1907.8	1987.8	3815.6	3975.6
519	1851.6	1931.6	3703.2	3863.2	613	1870.4	1950.4	3740.8	3900.8	707	1889.2	1969.2	3778.4	3938.4	801	1908.0	1988.0	3816.0	3976.0
520	1851.8	1931.8	3703.6	3863.6	614	1870.6	1950.6	3741.2	3901.2	708	1889.4	1969.4	3778.8	3938.8	802	1908.2	1988.2	3816.4	3976.4
521	1852.0	1932.0	3704.0	3864.0	615	1870.8	1950.8	3741.6	3901.6	709	1889.6	1969.6	3779.2	3939.2	803	1908.4	1988.4	3816.8	3976.8
522	1852.2	1932.2	3704.4	3864.4	616	1871.0	1951.0	3742.0	3902.0	710	1889.8	1969.8	3779.6	3939.6	804	1908.6	1988.6	3817.2	3977.2
523	1852.4	1932.4	3704.8	3864.8	617	1871.2	1951.2	3742.4	3902.4	711	1890.0	1970.0	3780.0	3940.0	805	1908.8	1988.8	3817.6	3977.6
524	1852.6	1932.6	3705.2	3865.2	618	1871.4	1951.4	3742.8	3902.8	712	1890.2	1970.2	3780.4	3940.4	806	1909.0	1989.0	3818.0	3978.0
525	1852.8	1932.8	3705.6	3865.6	619	1871.6	1951.6	3743.2	3903.2	713	1890.4	1970.4	3780.8	3940.8	807	1909.2	1989.2	3818.4	3978.4
526	1853.0	1933.0	3706.0	3866.0	620	1871.8	1951.8	3743.6	3903.6	714	1890.6	1970.6	3781.2	3941.2	808	1909.4	1989.4	3818.8	3978.8
527	1853.2	1933.2	3706.4	3866.4	621	1872.0	1952.0	3744.0	3904.0	715	1890.8	1970.8	3781.6	3941.6	809	1909.6	1989.6	3819.2	3979.2
528	1853.4	1933.4	3706.8	3866.8	622	1872.2	1952.2	3744.4	3904.4	716	1891.0	1971.0	3782.0	3942.0	810	1909.8	1989.8	3819.6	3979.6
529	1853.6	1933.6	3707.2	3867.2	623	1872.4	1952.4	3744.8	3904.8	717	1891.2	1971.2	3782.4	3942.4					
530	1853.8	1933.8	3707.6	3867.6	624	1872.6	1952.6	3745.2	3905.2	718	1891.4	1971.4	3782.8	3942.8					
531	1854.0	1934.0	3708.0	3868.0	625	1872.8	1952.8	3745.6	3905.6	719	1891.6	1971.6	3783.2	3943.2					
532	1854.2	1934.2	3708.4	3868.4	626	1873.0	1953.0	3746.0	3906.0	720	1891.8	1971.8	3783.6	3943.6					
533	1854.4	1934.4	3708.8	3868.8	627	1873.2	1953.2	3746.4	3906.4	721	1892.0	1972.0	3784.0	3944.0					
534	1854.6	1934.6	3709.2	3869.2	628	1873.4	1953.4	3746.8	3906.8	722	1892.2	1972.2	3784.4	3944.4					
535	1854.8	1934.8	3709.6	3869.6	629	1873.6	1953.6	3747.2	3907.2	723	1892.4	1972.4	3784.8	3944.8					
536	1855.0	1935.0	3710.0	3870.0	630	1873.8	1953.8	3747.6	3907.6	724	1892.6	1972.6	3785.2	3945.2					
537	1855.2	1935.2	3710.4	3870.4	631	1874.0	1954.0	3748.0	3908.0	725	1892.8	1972.8	3785.6	3945.6					
538	1855.4	1935.4	3710.8	3870.8	632	1874.2	1954.2	3748.4	3908.4	726	1893.0	1973.0	3786.0	3946.0					
539	1855.6	1935.6	3711.2	3871.2	633	1874.4	1954.4	3748.8	3908.8	727	1893.2	1973.2	3786.4	3946.4					
540	1855.8	1935.8	3711.6	3871.6	634	1874.6	1954.6	3749.2	3909.2	728	1893.4	1973.4	3786.8	3946.8					
541	1856.0	1936.0	3712.0	3872.0	635	1874.8	1954.8	3749.6	3909.6	729	1893.6	1973.6	3787.2	3947.2					
542	1856.2	1936.2	3712.4	3872.4	636	1875.0	1955.0	3750.0	3910.0	730	1893.8	1973.8	3787.6	3947.6					
543	1856.4	1936.4	3712.8	3872.8	637	1875.2	1955.2	3750.4	3910.4	731	1894.0	1974.0	3788.0	3948.0					
544	1856.6	1936.6	3713.2	3873.2	638	1875.4	1955.4	3750.8	3910.8	732	1894.2	1974.2	3788.4	3948.4					
545	1856.8	1936.8	3713.6	3873.6	639	1875.6	1955.6	3751.2	3911.2	733	1894.4	1974.4	3788.8	3948.8					
546	1857.0	1937.0	3714.0	3874.0	640	1875.8	1955.8	3751.6	3911.6	734	1894.6	1974.6	3789.2	3949.2					
547	1857.2	1937.2	3714.4	3874.4	641	1876.0	1956.0	3752.0	3912.0	735	1894.8	1974.8	3789.6	3949.6					
548	1857.4	1937.4	3714.8	3874.8	642	1876.2	1956.2	3752.4	3912.4	736	1895.0	1975.0	3790.0	3950.0					
549	1857.6	1937.6	3715.2	3875.2	643	1876.4	1956.4	3752.8	3912.8	737	1895.2	1975.2	3790.4	3950.4					
550	1857.8	1937.8	3715.6	3875.6	644	1876.6	1956.6	3753.2	3913.2	738	1895.4	1975.4	3790.8	3950.8					
551	1858.0	1938.0	3716.0	3876.0	645	1876.8	1956.8	3753.6	3913.6	739	1895.6	1975.6	3791.2	3951.2					
552	1858.2	1938.2	3716.4	3876.4	646	1877.0	1957.0	3754.0	3914.0	740	1895.8	1975.8	3791.6	3951.6					
553	1858.4	1938.4	3716.8	3876.8	647	1877.2	1957.2	3754.4	3914.4	741	1896.0	1976.0	3792.0	3952.0					
554	1858.6	1938.6	3717.2	3877.2	648	1877.4	1957.4	3754.8	3914.8	742	1896.2	1976.2	3792.4	3952.4					
555	1858.8	1938.8	3717.6	3877.6	649	1877.6	1957.6	3755.2	3915.2	743	1896.4	1976.4	3792.8	3952.8					
556	1859.0	1939.0	3718.0	3878.0	650	1877.8	1957.8	3755.6	3915.6	744	1896.6	1976.6	3793.2	3953.2					
557	1859.2	1939.2	3718.4	3878.4	651	1878.0	1958.0	3756.0	3916.0	745	1896.8	1976.8	3793.6	3953.6					
558	1859.4	1939.4	3718.8	3878.8	652	1878.2	1958.2	3756.4	3916.4	746	1897.0	1977.0	3794.0	3954.0					
559	1859.6	1939.6	3719.2	3879.2	653	1878.4	1958.4	3756.8	3916.8	747	1897.2	1977.2	3794.4	3954.4					
560	1859.8	1939.8	3719.6	3879.6	654	1878.6	1958.6	3757.2	3917.2	748	1897.4	1977.4	3794.8	3954.8					
561	1860.0	1940.0	3720.0	3880.0	655	1878.8	1958.8	3757.6	3917.6	749	1897.6	1977.6	3795.2	3955.2					
562	1860.2	1940.2	3720.4	3880.4	656	1879.0	1959.0	3758.0	3918.0	750	1897.8	1977.8	3795.6	3955.6					
563	1860.4	1940.4	3720.8	3880.8	657	1879.2	1959.2	3758.4	3918.4	751	1898.0	1978.0	3796.0	3956.0					
564	1860.6	1940.6	3721.2	3881.2	658	1879.4	1959.4	3758.8	3918.8	752	1898.2	1978.2	3796.4	3956.4					
565	1860.8	1940.8	3721.6	3881.6	659	1879.6	1959.6	3759.2	3919.2	753	1898.4	1978.4	3796.8	3956.8					
566	1861.0	1941.0	3722.0	3882.0	660	1879.8	1959.8	3759.6	3919.6	754	1898.6	1978.6	3797.2	3957.2					
567	1861.2	1941.2	3722.4	3882.4	661	1880.0	1960.0	3760.0	3920.0	755	1898.8	1978.8	3797.6	3957.6					
568	1861.4	1941.4	3722.8	3882.8	662	1880.2	1960.2	3760.4	3920.4	756	1899.0	1979.0	3798.0	3958.0					
569	1861.6	1941.6	3723.2	3883.2	663	1880.4	1960.4	3760.8	3920.8	757	1899.2	1979.2	3798.4	3958.4					
570	1861.8	1941.8	3723.6	3883.6	664	1880.6	1960.6	3761.2	3921.2	758	1899.4	1979.4	3798.8	3958.8					
571	1862.0	1942.0	3724.0	3884.0	665	1880.8	1960.8	3761.6	3921.6	759	1899.6	1979.6	3799.2	3959.2					
572	1862.2	1942.2	3724.4	3884.4	666	1881.0	1961.0	3762.0	3922.0	760	1899.8	1979.8	3799.6	3959.6					
573	1862.4	1942.4	3724.8	3884.8	667	1881.2	1961.2	3762.4	3922.4	761	1900.0	1980.0	3800.0	3960.0					
575	1862.8	1942.8	3725.6	3885.6	669	1881.6	1961.6	3763.2	3923.2	763	1900.4	1980.4	3800.8	3960.8					
576																			

## Phoenix tuning

Before any tuning the phone should be synchronised with the PC.

Connect the phone to a PC with DAU-9P cable and dongle and follow the following instructions:

Provide the phone with power supply

Start Phoenix Service Software and open FBUS connection

Select            File    Scan Product

Wait until phone information is shown in the lower right corner of the screen.

## RF tuning after repairs

Different repairs require different tuning. In general it is necessary to determine in which section the repair was done to select which tunings to perform. To determine if RF tuning is necessary after repair it is important that the functionality of the repaired circuit is understood well.

- In general repairs in the TX part will require "TX Power Level Tuning" and "TX IQ Tuning".
- In general repairs in the RX part or PLL part always require "RX Calibration", "Rx Band Filter Response Calibration".
- If Mjoelner is changed all calibrations have to be done.

Other parts interfacing to TX, RX or PLL might require tuning, but common sense should be used, e.g. if a component that has no influence on RF performance has been changed, e.g. the microphone, on/off key, mechanical parts or similar, there is no need to do any RF tuning.

## RX Calibration (incl. VCXO Calibration)

The "RX calibration" is used to determine gain at different gain-settings for front-end and Mjoelner and needs to be done in all three bands.

RX-calibration requires an external signal generator.

RX-calibration in EGSM900 combines two tunings, VCXO-calibration and AGC-calibration:

Calibration of GSM1800 and GSM1900 band only determines AGC values.

The **VCXO-calibration** finds out a calibration value for VCXO control, an AFC initial value and 3 AFC-slope coefficients.

A value (RF\_TEMP), which represents the RF hardware temperature, is determined during RX Calibration. This temperature value is used by DSP to RSSI reporting in Normal mode of the phone. It is not visible in the calibration process.

**AGC-calibration:**

The AGC-calibration finds the gain values of the RX-gain system. The AGC consists of RF LNA, which can be either on or off (gain difference between on and off state is nominally 30dB) and BB gain which can be controlled in 6dB steps. This gives 15 gain steps RSSI0 to RSSI14. LNA is off for steps RSSI0 to RSSI4. AGC-calibration measures the gain at gain step RSSI4 and RSSI7. The other gain values are calculated.

**VCXO-calibration:**

The VCXO-calibration ensures the function of an **initial** synchronization (before location update is done) when the mobile station is in Normal mode. For an error free initial synchronization, the 26MHz frequency of the VCXO must be accurate enough. Therefore, a **VCXO cal** value is written into the RefOSCCAL register of the Mjoelner.

During VCXO-calibration, the **VCXO cal** value is changed by a DSP-algorithm until a synchronization is possible. This means the VCXO oscillates at 26 MHz with a sufficient minimum frequency error.

To further minimize the frequency error, an initial **AFC value** is determined by the DSP and written into RefOSCAFC register of the Mjoelner.

Also the DSP algorithm determines 3 AFC slope coefficients **Slope C1...3** during VCXO calibration. One AFC slope value is not sufficient for Mjoelner **F3**, because the AFC slope is non-linear in this chip.

**EGSM**

Set operating mode to local mode

Select	RF	Alt-M
	Tuning	T
	RX Calibration	C
Wait until the RX Calibration window pops up.		
Select	Band	GSM 900
	Autom.-	60

The setup should now look like this:

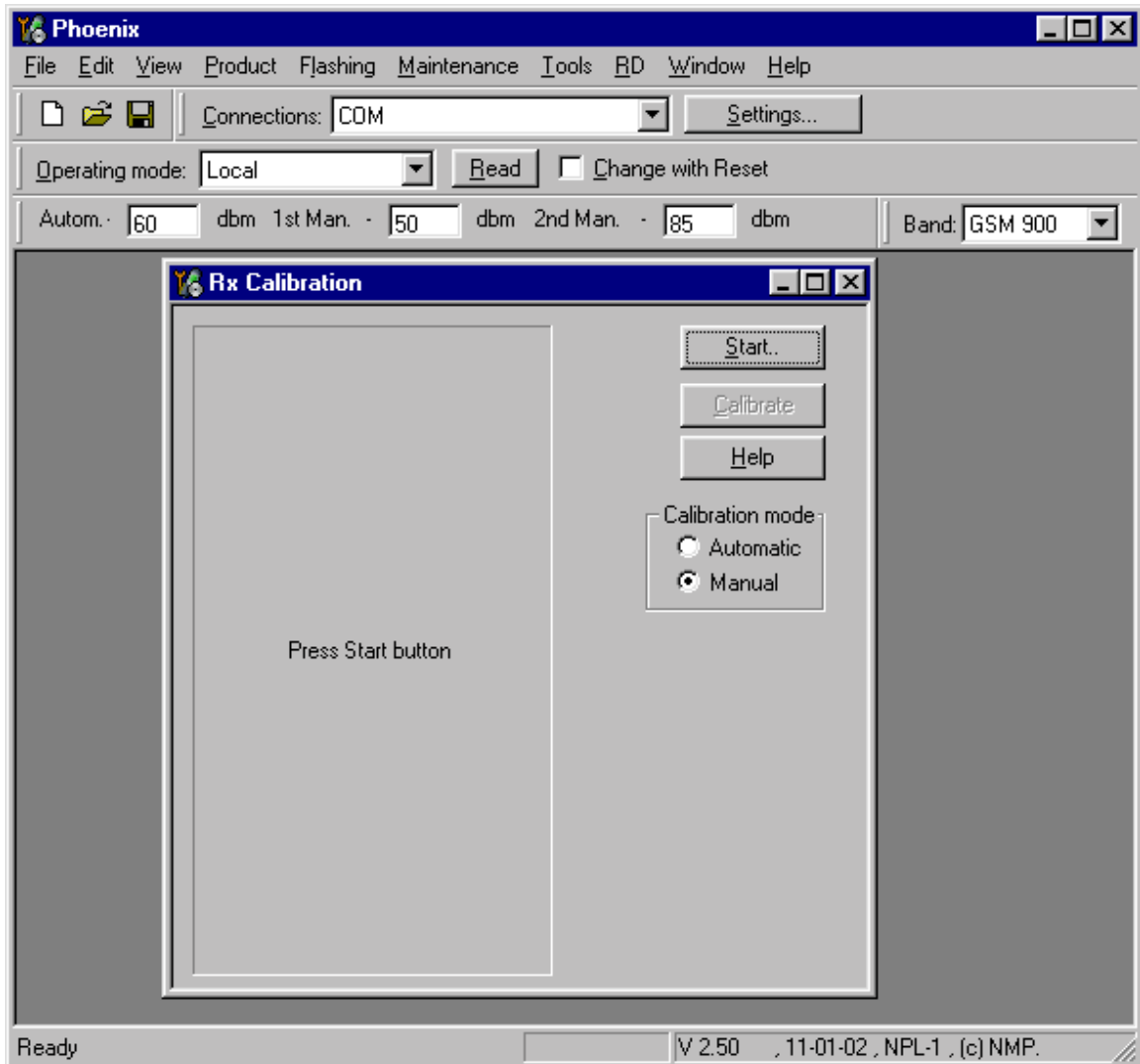

Select Automatic, press Start and a new window pops up:

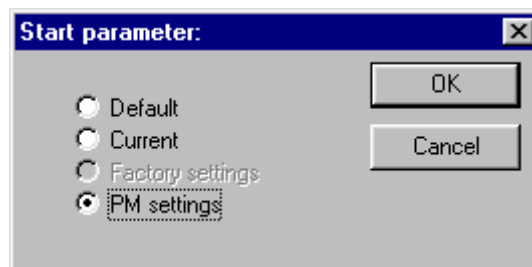

Select PM settings, press OK and the window closes.

Now it is possible to press the calibrate button in the RX Calibration window.

Press Calibrate and a window pops up:

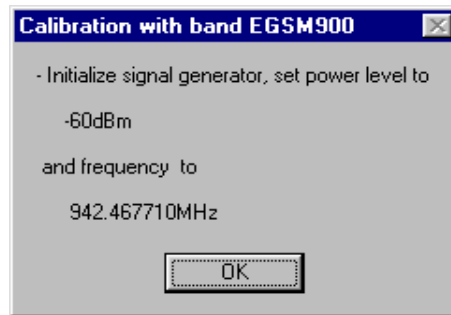

Connect an external signal generator to the RF connector of the phone and set the generator as told in the window, taking care for external cable losses.

Press ok and the window closes.

A typical result will look like this:

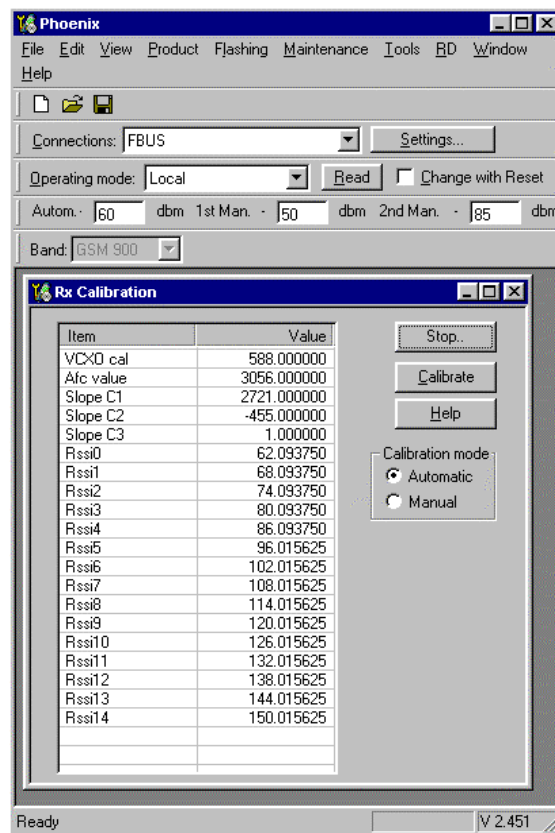

Press Stop in the RX Calibration window and a new window pops up:

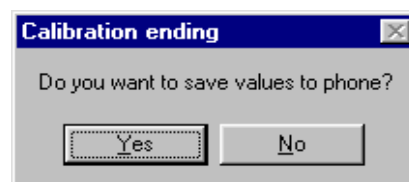

Press Yes and the EGSM RX Calibration is finished.

### GSM1800 (DCS/PCN)

Set operating mode to local mode

- |        |                |       |
|--------|----------------|-------|
| Select | RF             | Alt-M |
|        | Tuning         | T     |
|        | RX Calibration | C     |

Wait until the RX Calibration window pops up.

- |        |                      |          |
|--------|----------------------|----------|
| Select | Band                 | GSM 1800 |
|        | Autom.               | -60      |
|        | 1 <sup>st</sup> Man. | -50      |
|        | 2 <sup>nd</sup> Man. | -85      |

The setup should now look like this:

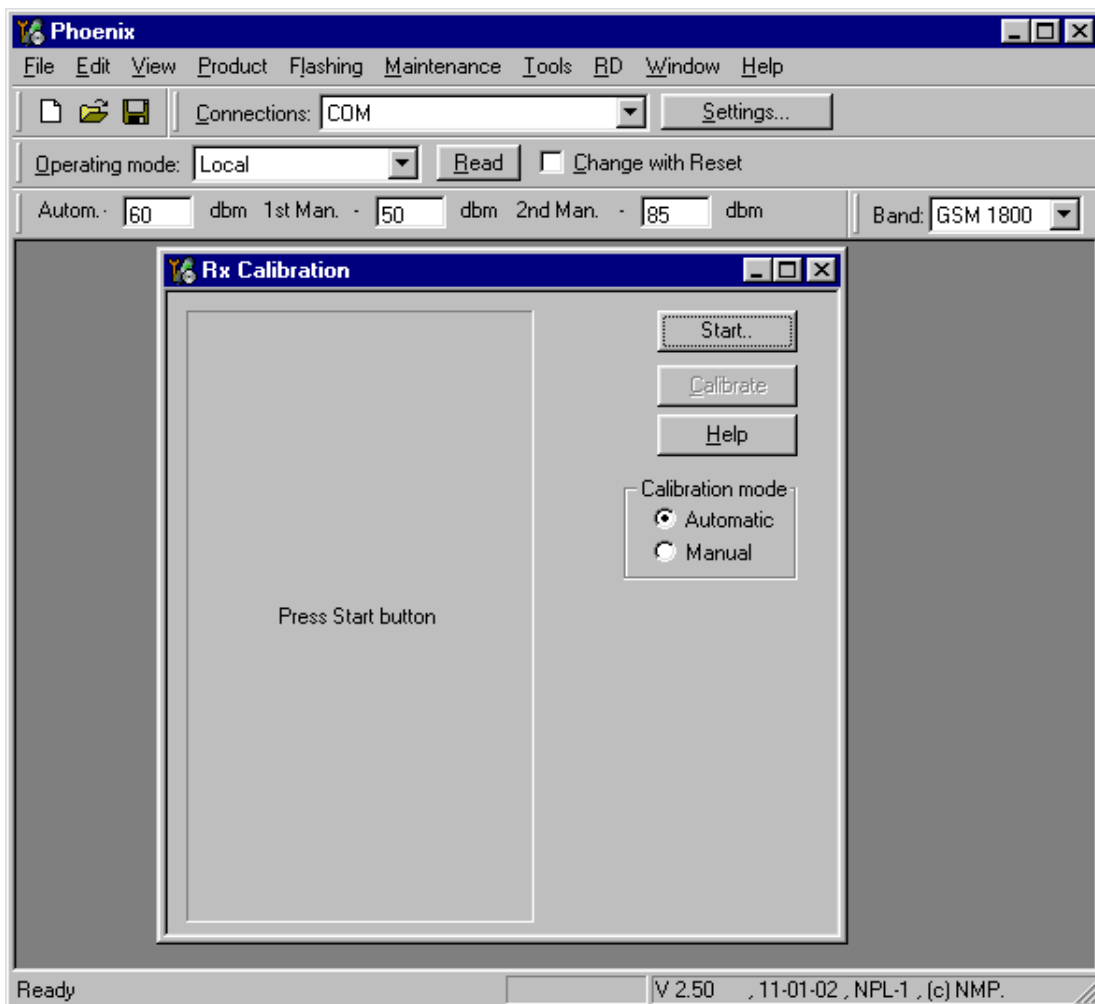



Select Automatic, press Start and a new window pops up:

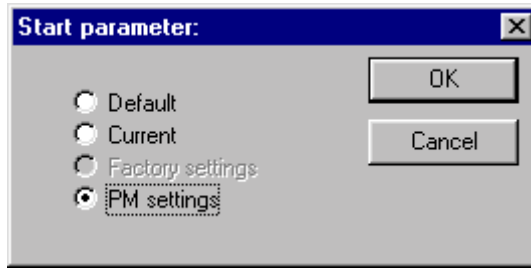

Select PM settings, press OK and the window closes.

Now it is possible to press the calibrate button in the RX Calibration window.

Press Calibrate and a window pops up:

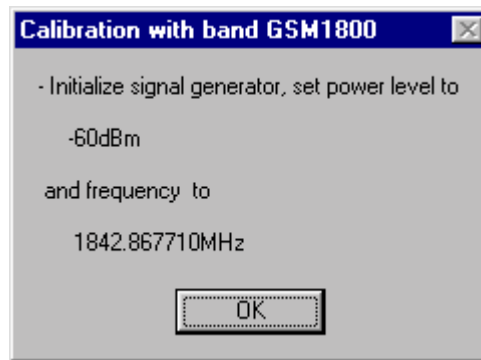

Connect an external signal generator to the RF connector of the phone and set the generator as told in the window, taking care for external cable losses.

Press ok and the window closes.

A typical result will look like this:

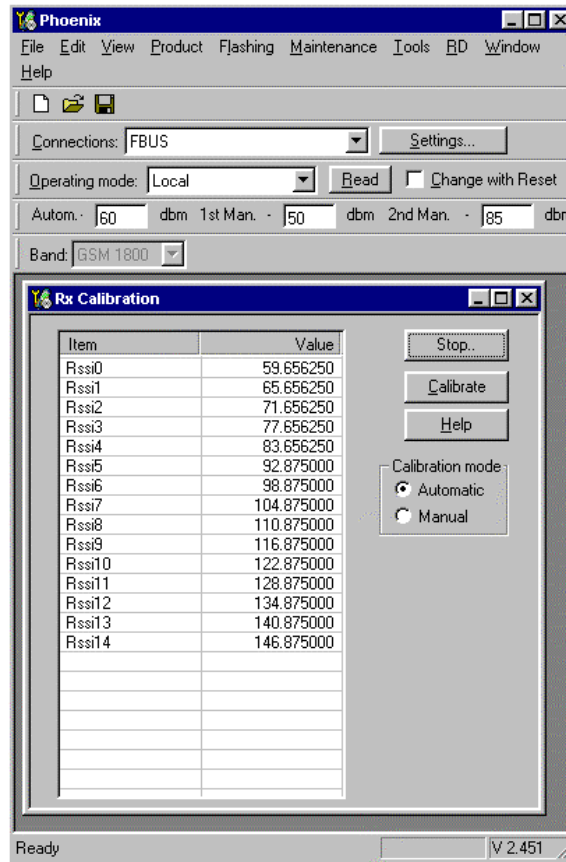

Press Stop in the RX Calibration window and a new window pops up:

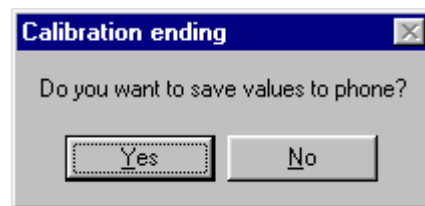

Press Yes and the GSM1800 RX Calibration is finished.

### GSM1900 (PCS)

Set operating mode to local mode

Select	RF	Alt-M
	Tuning	T
	RX Calibration	C

Wait until the RX Calibration window pops up.

Select	Band	GSM 1900
	Autom.	-60
	1 <sup>st</sup> Man.	-50
	2 <sup>nd</sup> Man.	-85

The setup should now look like this:

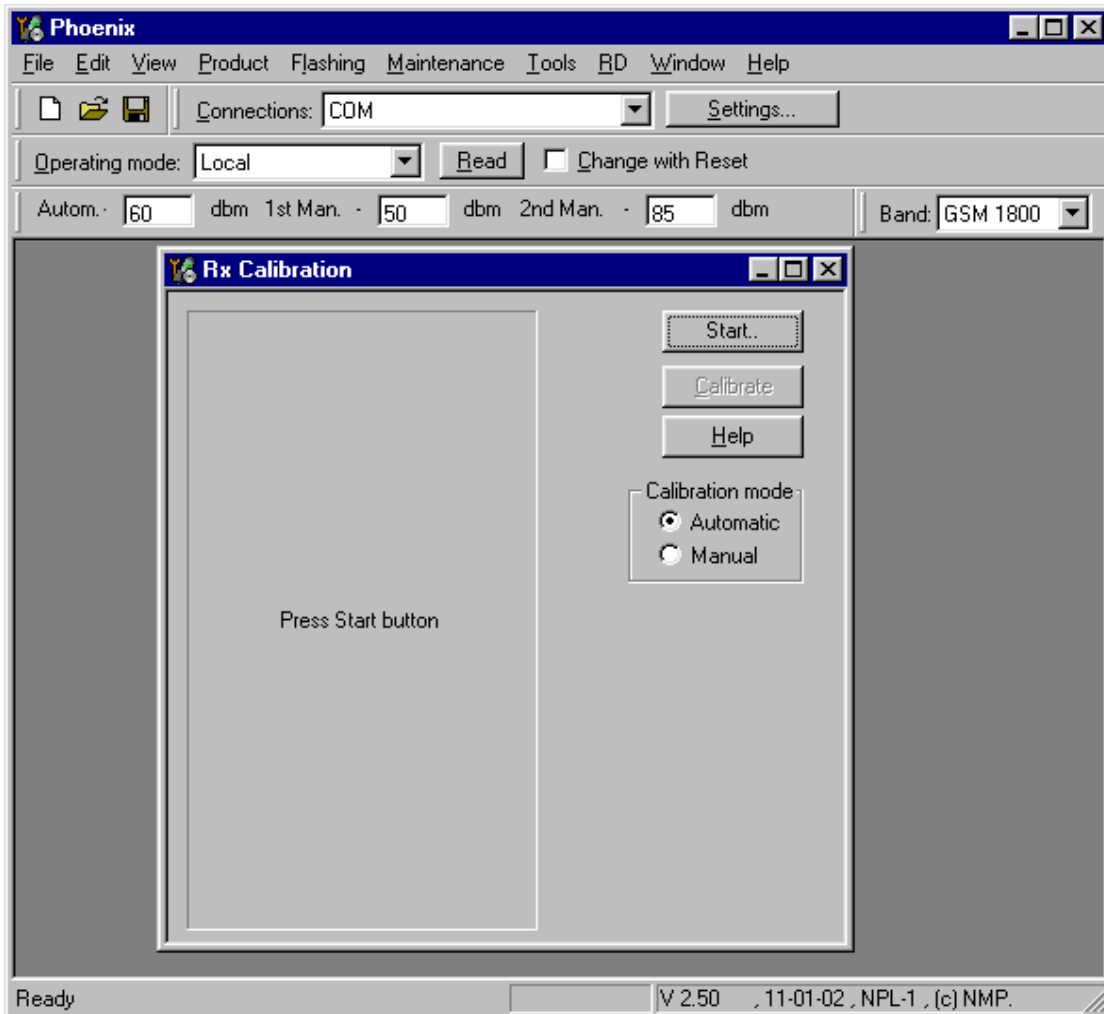

Select Automatic, press Start and a new window pops up:

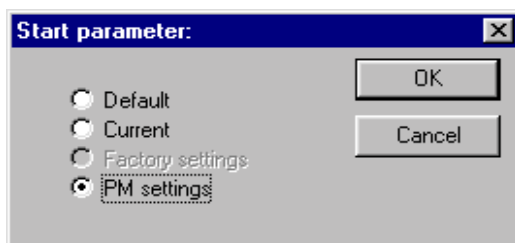

Select PM settings, press OK and the window closes.

Now it is possible to press the calibrate button in the RX Calibration window.

Press Calibrate and a window pops up:

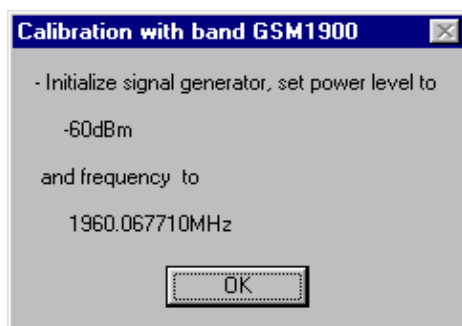

Connect an external signal generator to the RF connector of the phone and set the generator as told in the window, taking care for external cable losses.

Press OK and the window closes.

A typical result will look like this:

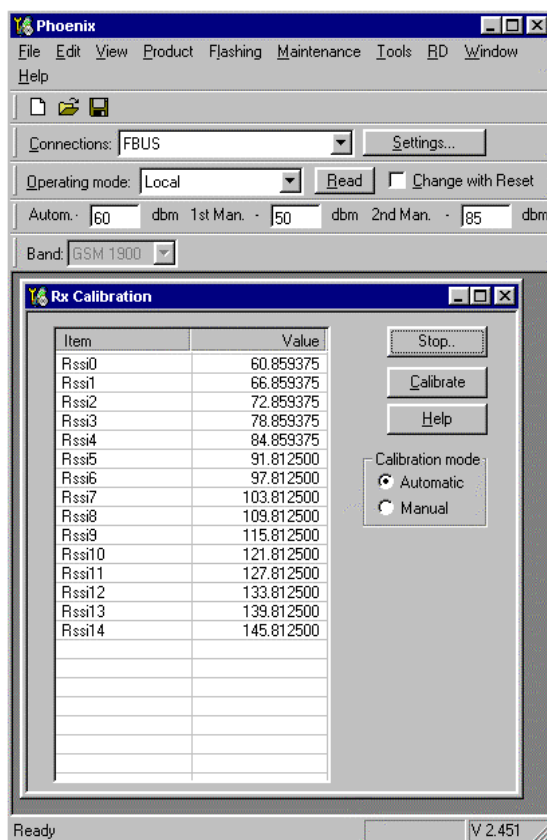

Press Stop in the RX Calibration window and a new window pops up:

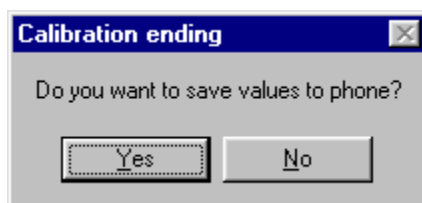

Press Yes and the GSM1900 RX Calibration is finished.

### RX AGC limits

The Rx calibration is only valid if it is within certain limits.

For the most recent limits see NHL-8 Production Testing Requirements,

If calibration is not within limits, there is a fault in the RX chain.

Below the values for RSSI4 and RSSI7 are given:



The setup should now look like this:

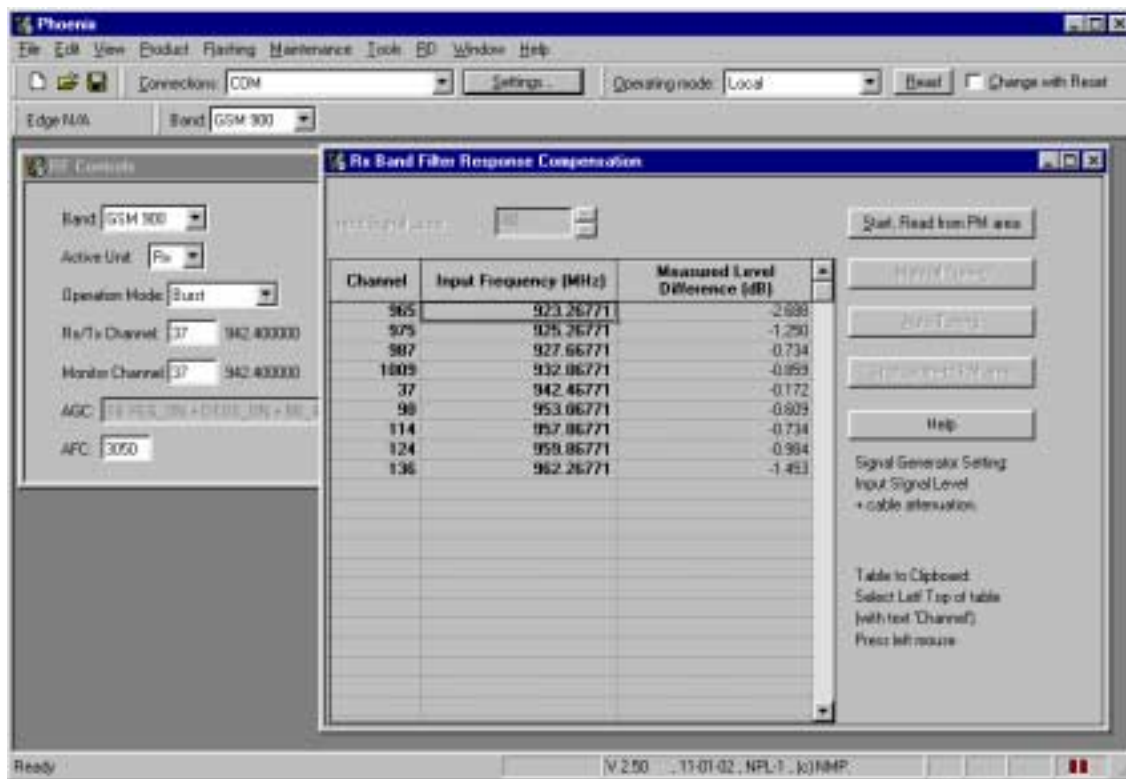

Select Input Signal Level -60dBm

### Manual Tuning

Press Manual tuning and a window pops up:

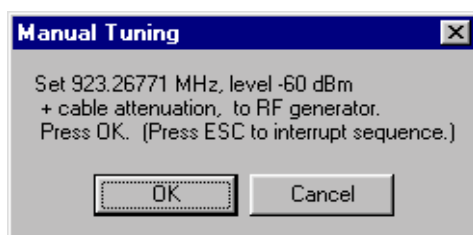

Connect an external signal generator to the RF connector of the phone and set the generator as told in the window.

Press OK and a new window pops up:

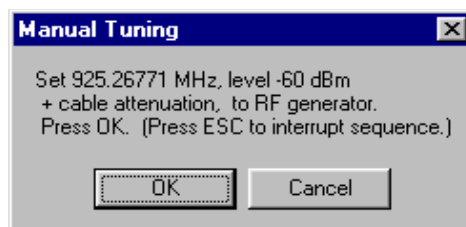

Set the generator as told in the window.

Press OK and a new window pops up. Repeat this sequence **9 times** until all channels are done.

Press Stop, Write to PM Area (In the RX Band Filter Response Compensation window) and a window pops up:

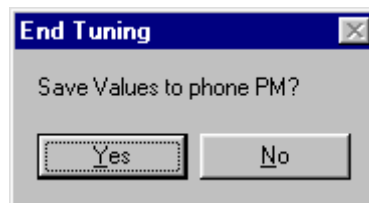

Press Yes and the EGSM RX Band Filter Response Compensation is finished.

### Auto Tuning

A faster and more convenient method for Band Filter Calibration can be performed by clicking on "Auto Tuning". This requires a signal Generator that can be programmed to see a user defined list of frequencies.

Program the signal generator to the list of frequencies that are visible in the column "Input Frequency (MHz)" .

Press Auto tuning and a window pops up:

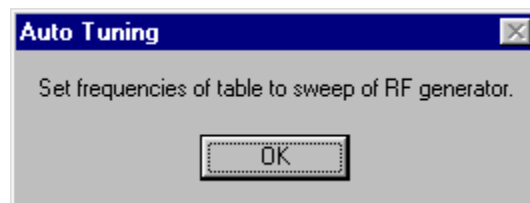

Connect an external signal generator to the RF connector of the phone and let the signal generator step sweep through the programmed frequency list.

Press OK.

Press Stop, Write to PM Area (In the RX Band Filter Response Compensation window) and a window pops up:

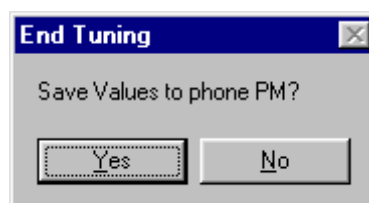

Press Yes and the EGSM RX Band Filter Response Compensation is finished.



**GSM1800 (DCS/PCN)**

Set operating mode to local mode

- Select RF Alt-M
- Tuning T
- RF Controls F

Wait until the RF Controls window pops up

- Select Band GSM 1800

- Select Maintenance Alt-M
- Tuning T
- RX Band Filter Response Compensation B

Following window pops up:

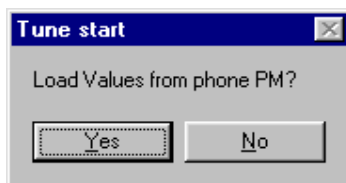

Select Yes and the RX Band Filter Response Compensation window pops up.

The setup should now look like this:

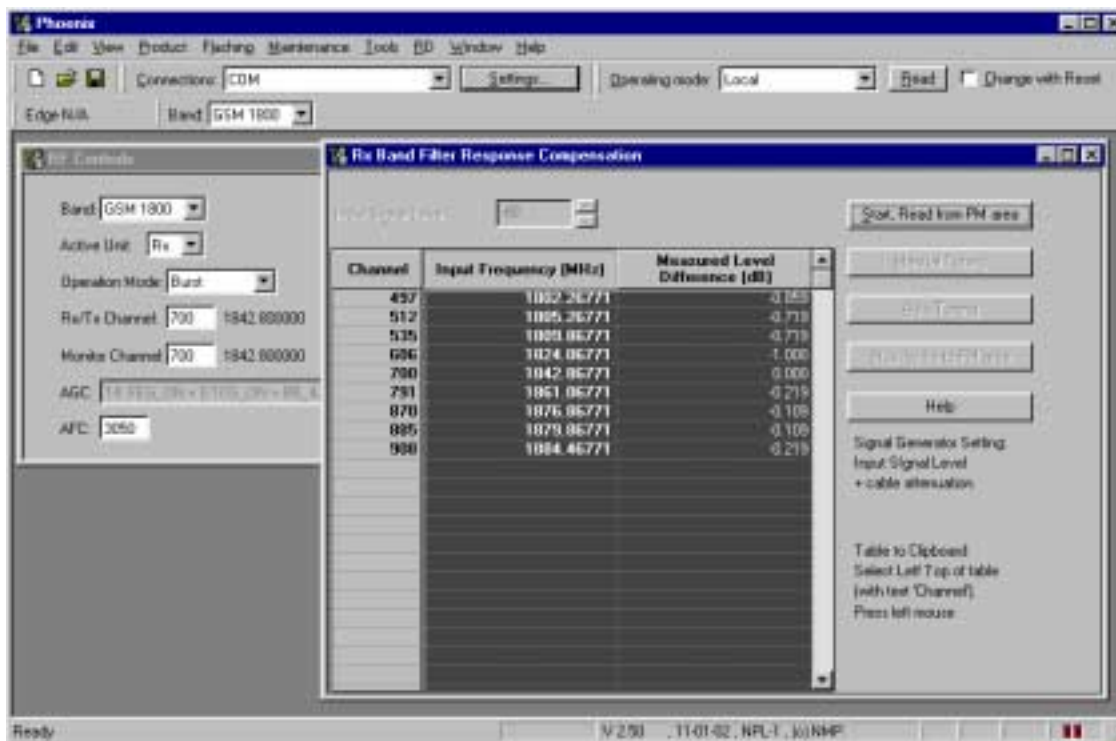

- Select Input Signal Level -60dBm

## Manual Tuning

Press Manual tuning and a window pops up:

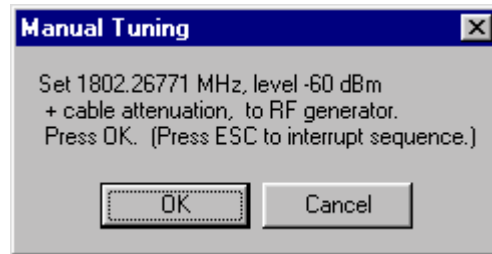

Connect an external signal generator to the RF connector of the phone and set the generator as told in the window.

Press OK and a new window pops up:

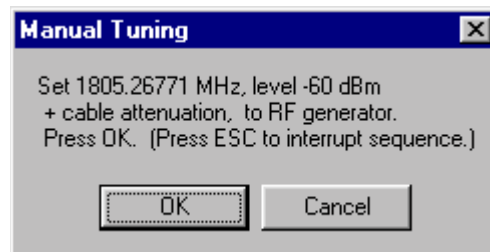

Set the generator as told in the window.

Press OK and a new window pops up. Repeat this sequence **9 times** until all channels are done.

Press Stop, Write to PM Area (In the RX Band Filter Response Compensation window) and a window pops up:

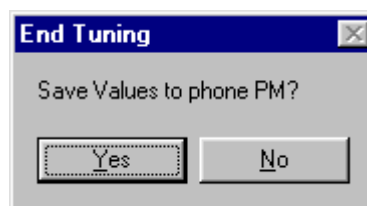

Press Yes and the EGSM RX Band Filter Response Compensation is finished.

## Auto Tuning

A faster and more convenient method for Band Filter Calibration can be performed by clicking on "Auto Tuning". This requires a signal Generator that can be programmed to seep a user defined list of frequencies.

Program the signal generator to the list of frequencies that are visible in the column "Input Frequency (MHz)".

Press Auto tuning and a window pops up:



Connect an external signal generator to the RF connector of the phone and let the signal generator step sweep through the programmed frequency list.

Press OK.

Press Stop, Write to PM Area (In the RX Band Filter Response Compensation window) and a window pops up:

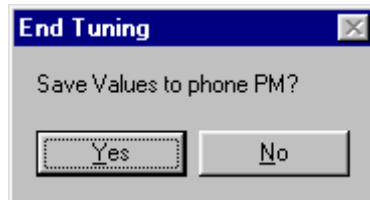

Press Yes and the EGSM RX Band Filter Response Compensation is finished.

**GSM1900 (PCS)**

Set operating mode to local mode

Select	RF		Alt-M
		Tuning	T
		RF Controls	F

Wait until the RF Controls window pops up

Select	Band	GSM 1900
--------	------	----------

Select	RF		Alt-M
		Tuning	T
		RX Band Filter Response Compensation	B

A window pops up:

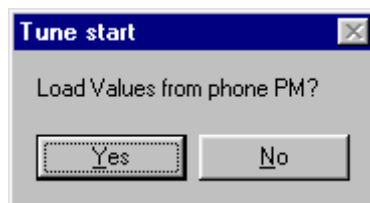

Select Yes and the RX Band Filter Response Compensation window pops up.

The setup should now look like this:

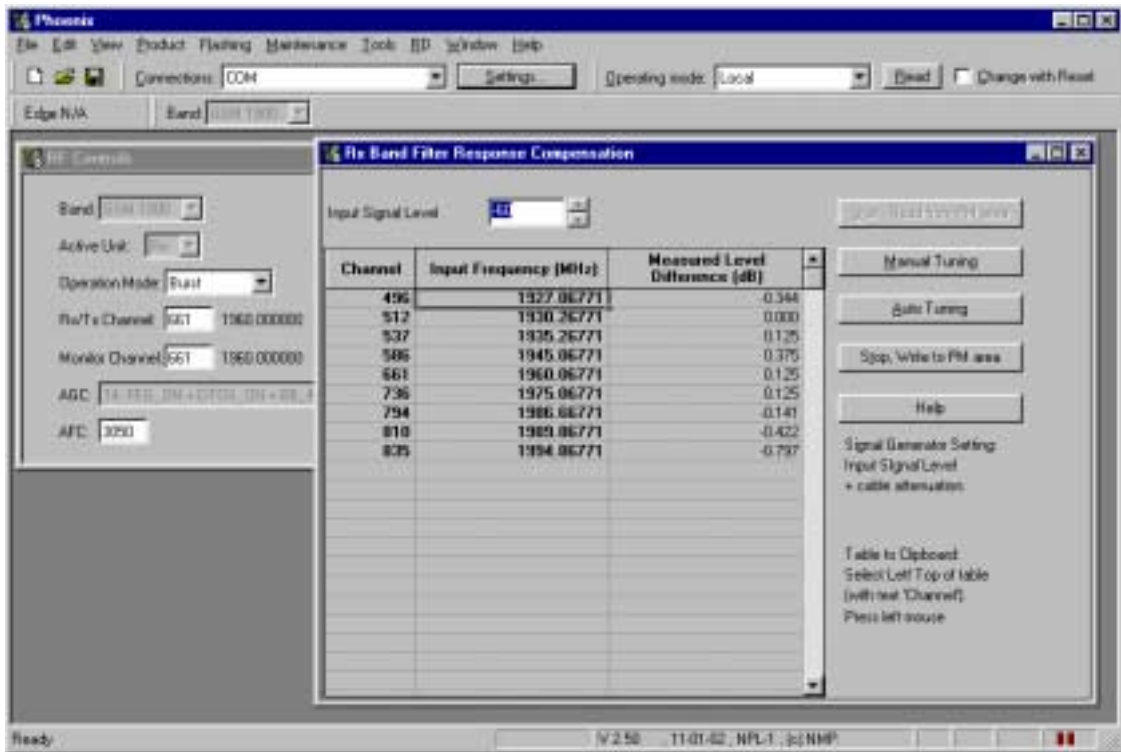

Select  -60dBm

### Manual Tuning

Press Manual tuning and a window pops up:

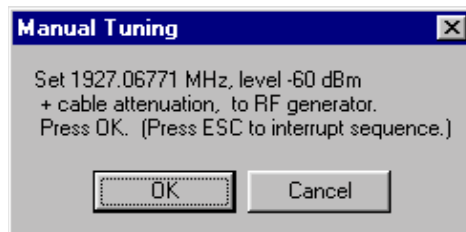

Connect an external signal generator to the RF connector of the phone and set the generator as told in the window.

Press OK and a new window pops up:

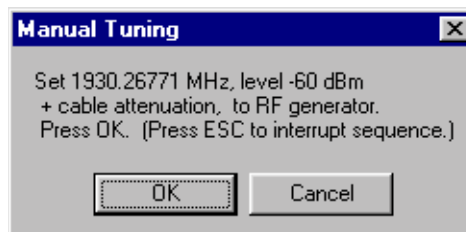

Set the generator as told in the window.

Press OK and a new window pops up. Repeat this sequence **9 times** until all channels are done.

Press Stop, Write to PM Area (In the RX Band Filter Response Compensation window) and a window pops up:

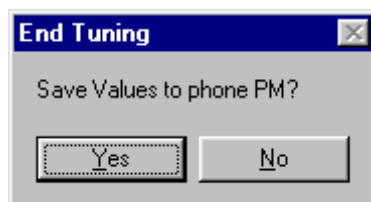

Press Yes and the EGSM RX Band Filter Response Compensation is finished.

### Auto Tuning

A faster and more convenient method for Band Filter Calibration can be performed by clicking on "Auto Tuning". This requires a signal Generator that can be programmed to see a user defined list of frequencies.

Program the signal generator to the list of frequencies that are visible in the column "Input Frequency (MHz)" .

Press Auto tuning and a window pops up:

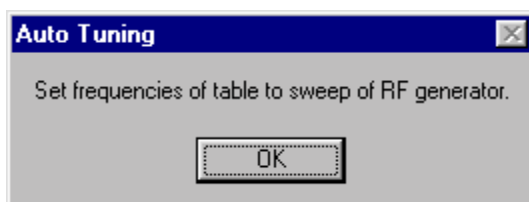

Connect an external signal generator to the RF connector of the phone and let the signal generator step sweep through the programmed frequency list.

Press OK.

Press Stop, Write to PM Area (In the RX Band Filter Response Compensation window) and a window pops up:

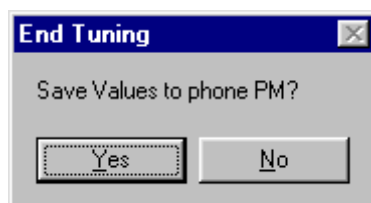

Press Yes and the EGSM RX Band Filter Response Compensation is finished.

### RX Channel Select Filter Calibration

This calibration is calibrating the Base band filter inside Mjoelner. It is done by internally



Press Stop and a new window pops up:

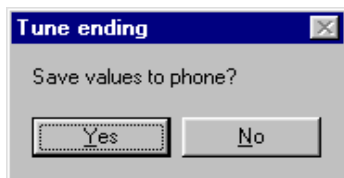

Press Yes and the RX Channel Select Filter Calibration is finished.

### TX Power tuning

This tuning must be done in all three bands.

Note: TX Power tuning must be done with a peak power meter, e.g. Anritsu model ML2408A with Anritsu Peak Power Sensor MA2442A and a suitable attenuator.

The use of power meter in GSM testers is likely to cause larger error than the use of a dedicated power meter and might cause the phone to be non-compliant with GSM specifications.

### EGSM (EGSM900)

Set operating mode to local mode

Select      RF                      Tuning                      TX Power Level Tuning

Wait until the TX Power Level Tuning window pops up.

Connect a **calibrated** powermeter to the RF connector of the phone.

Select      Band                      GSM 900  
   Active Unit                      TX

Press Start and a window pops up:

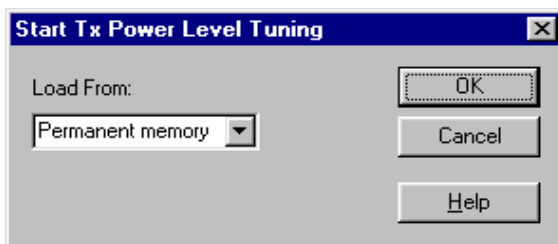

Select Permanent memory, press OK and the window closes.

Select                                      TX Data Type      Random

The setup should now look like this:

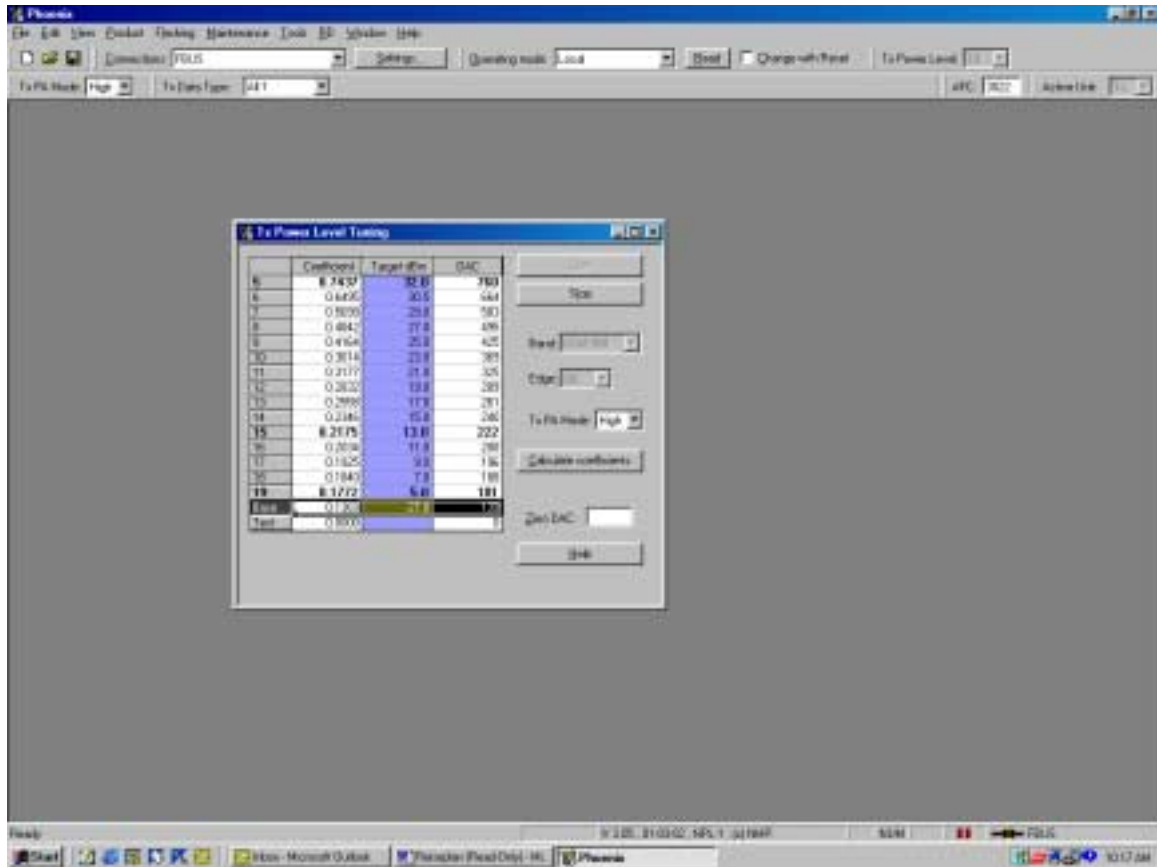

Select TX PA Mode High

Tune Base level to -27 dBm.

Adjust DAC Values for Power Level 5 (32.5 dBm), 15 (13 dBm) and 19 (5 dBm) according to Target values. The Power levels may differ from Phoenix mentioned target power levels.

Press calculate, check if all levels match the target values, correct if necessary.

Select TX PA Mode Low

Adjust DAC Values for Power Level 7, 15 and 19 according to Target values.

Press calculate, check if all levels match the target values, correct if necessary.

Press Stop and a window pops up:

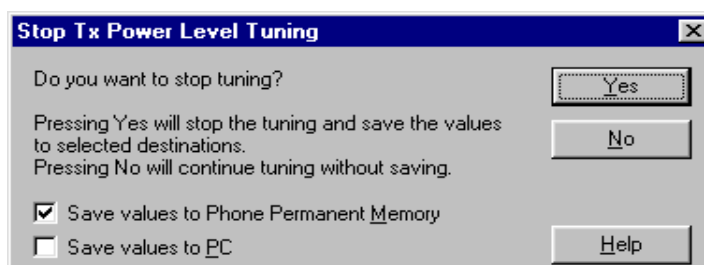



Select 'Save values to Phone Permanent Memory'

Press Yes and the EGSM TX Power Level Tuning is finished.

### GSM1800 (DCS/PCN)

Set operating mode to local mode

Select RF Tuning TX Power Level Tuning

Wait until the TX Power Level Tuning window pops up.

Connect a **calibrated** powermeter to the RF connector of the phone.

Select Band GSM 1800  
Active Unit TX

Press Start and a window pops up:

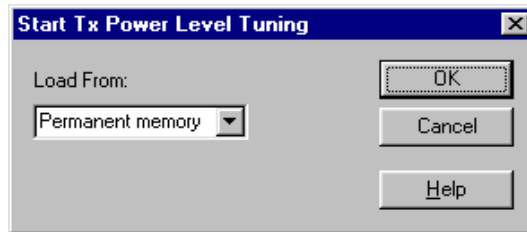

Select Permanent memory, press OK and the window closes.

Select TX Data Type Random

The setup should now look like this:

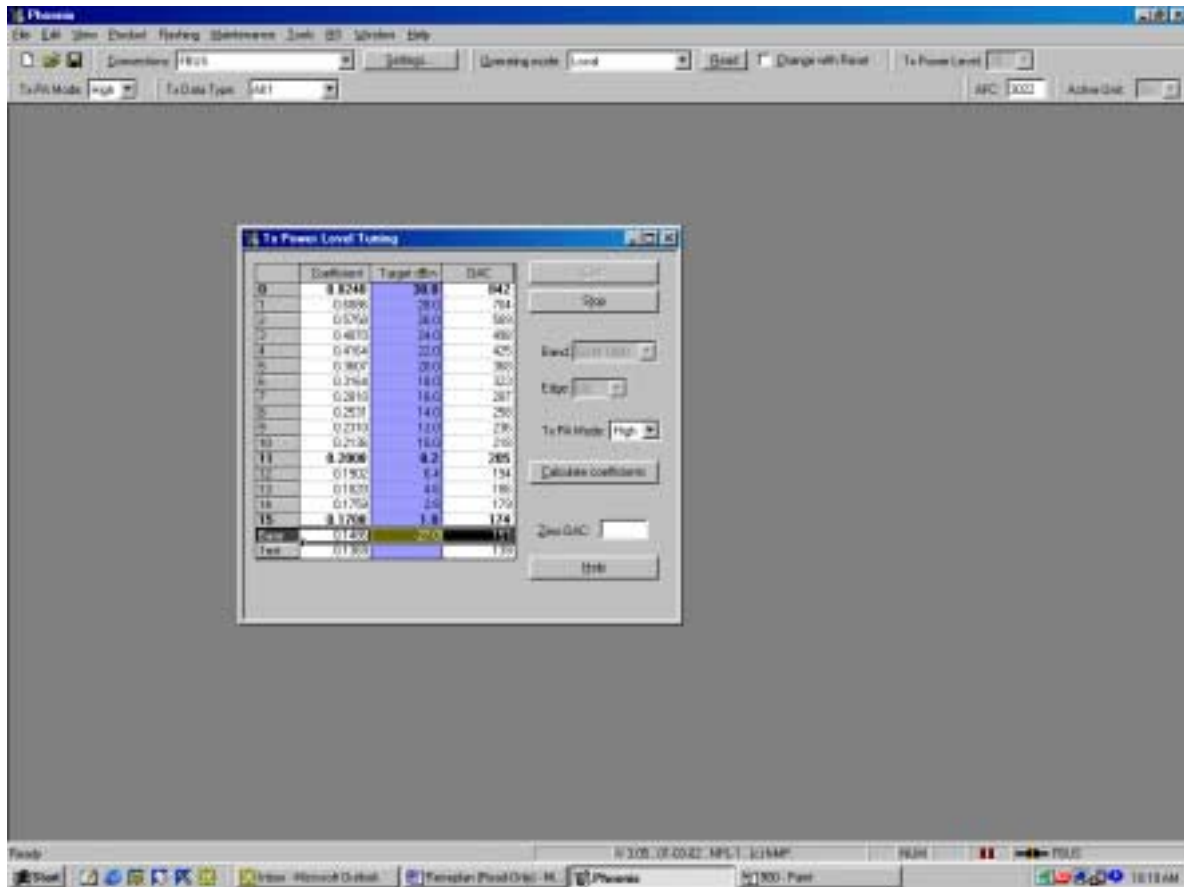

Select TX PA Mode High

Tune Base level to -27 dBm.

Adjust DAC Values for Power Level 0 (30 dBm), 11 (8.2 dBm) and 15 (1 dBm). The Power levels may differ from Phoenix mentioned target power levels.

Press calculate, check if all levels match the target values, correct if necessary.

Press Stop and a window pops up:

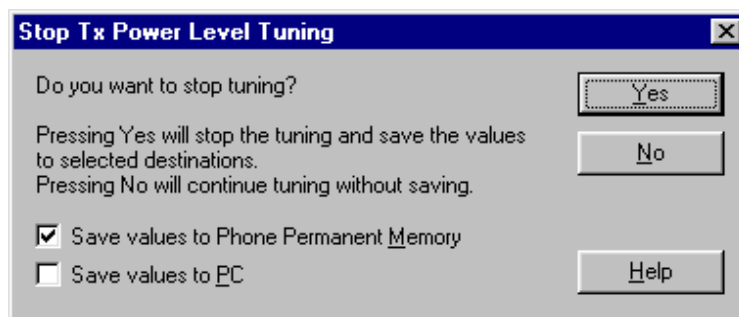

Select 'Save values to Phone Permanent Memory'

Press Yes and the GSM1800 TX Power Level Tuning is finished.

### GSM1900 (PCS)

Set operating mode to local mode

Select RF Tuning TX Power Level Tuning

Wait until the TX Power Level Tuning window pops up.

Connect a **calibrated** powermeter to the RF connector of the phone.

Select Band GSM 1900  
Active Unit TX

Press Start and a window pops up:

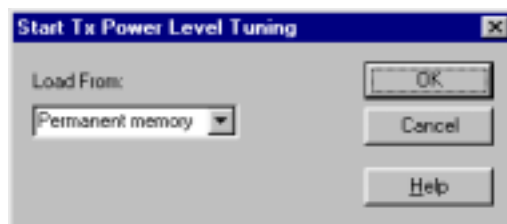

Select Permanent memory, press OK and the window closes.

Select TX Data Type Random

The setup should now look like this:

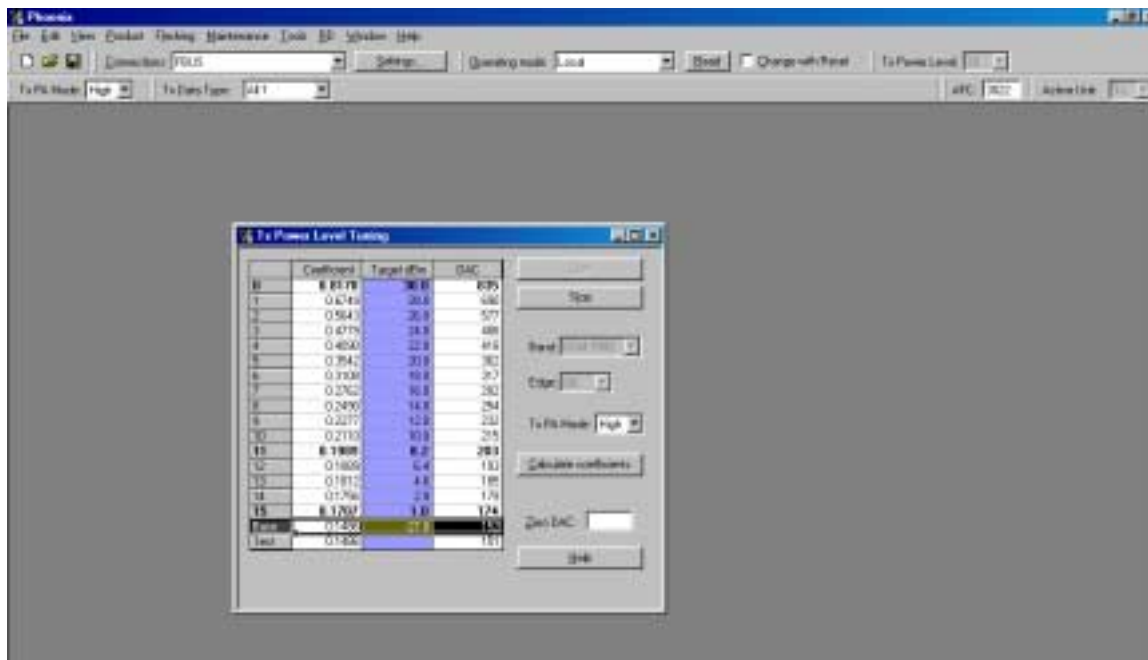

Select TX PA Mode High

Tune Base level to -27 dBm.

Adjust DAC Values for Power Level 0 (30 dBm), 11 (8.2 dBm) and 15 (1 dBm). The Power levels may differ from in Phoenix mentioned target power levels.

Press calculate, check if all levels match the target values, correct if necessary.

Press Stop and a window pops up:

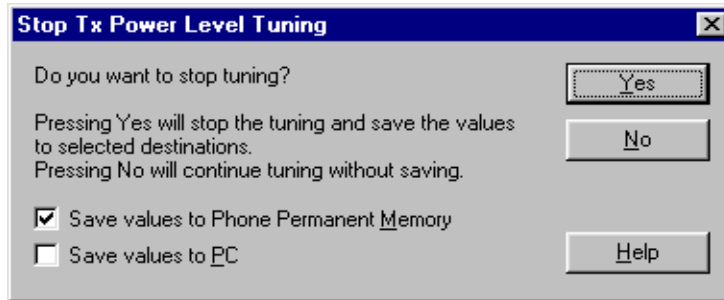

Select 'Save values to Phone Permanent Memory'

Press Yes and the GSM1900 TX Power Level Tuning is finished.

## TX I/Q Tuning

This tuning must be done in all three bands.

### EGSM (EGSM900)

**Caution:** In case you use a spectrum analyser make sure that the external attenuation (20 - 30dB) between phone and spectrum analyser is high enough that the input of the analyser can't be destroyed. Adjust the reference level offset according to the insertion loss from the phone to the spectrum analyser .

PC/Phone operation:

Set operating mode to local mode

Select	RF		Alt-M
		Tuning	T
		TX IQ Tuning	I

Wait until the TX IQ Tuning window pops up.

Select	RF		Alt-M
		Tuning	T
		RF Controls	F

Wait until the RF Controls window pops up.

Connect a Spectrum Analyzer or GSM tester with the option \*Narrow Spectrum' to the RF connector of the phone.

If a spectrum analyzer is used then use the following settings.

	<b>EGSM/EGSM900</b>
Center Frequency	897.4 MHz
Frequency Span	300 kHz
Resolution Bandwidth	3kHz
Video Bandwidth	3kHz
Sweep Time	3 sec.
Sweep Type	Clear/Write
Detector Type	Max Peak
Reference level	35 dBm
	EGSM/EGSM900
Marker 1	897.33229 MHz
Marker 2	897.4 MHz
Marker 3	897.46771 MHz

Select in the RF Controls Window:

```
Select      Band      GSM 900
Active Unit  TX
            Operation Mode  Burst
            RX/TX Channel   37
            TX PA Mode Free
            TX Data Type  All1
```

Select in the TX IQ Tuning Window:

```
Select      "Load from Product"
            "Save to Product"
```

Press Start

Select again in the RF Controls Window:

```
Select      TX Power Level  5
```

The setup should now look like this:

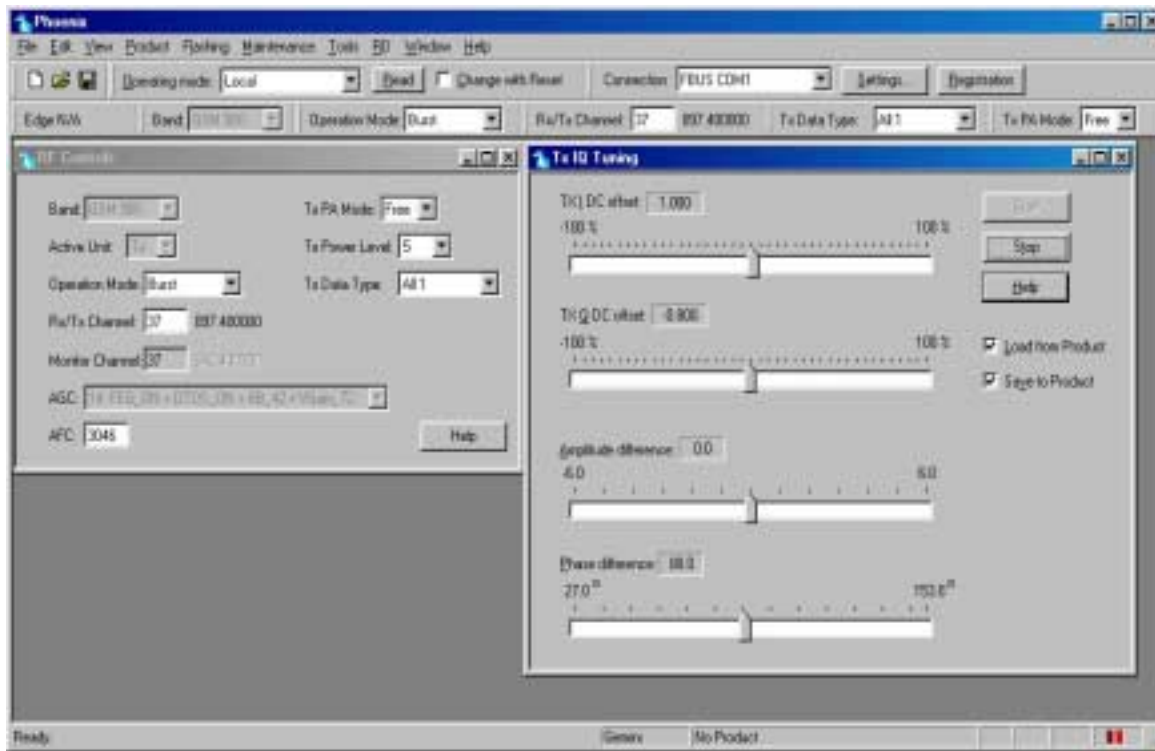

The Spectrum Analyzer now shows a plot like this:

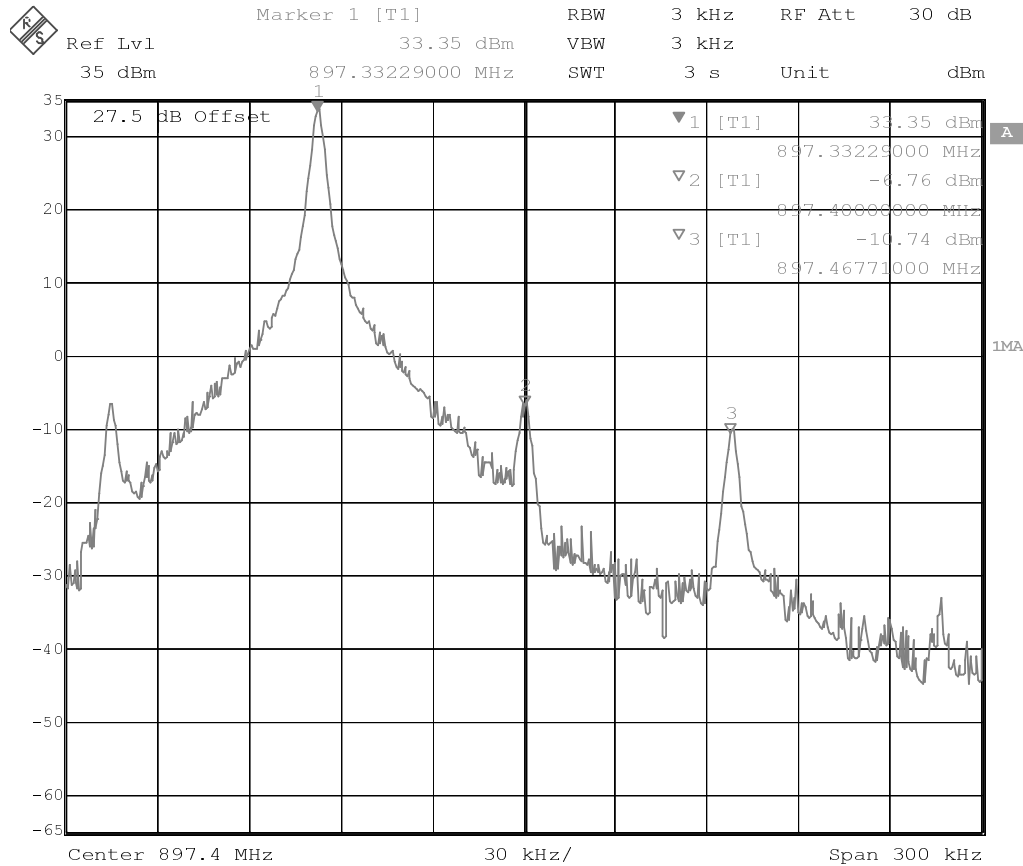

Date: 14.JAN.2002 13:11:55

The purpose of this tuning is to tune the carrier signal and the +67kHz signal to a minimum level (Marker 2 and 3).

Use the variables 'TX I DC offset' and 'TX Q DC offset' to adjust the carrier signal to a minimum level (Marker 2).

After tuning to the minimum the level difference between the peak levels at marker 1 and 2 must exceed 40dB.

Tuning is possible by using arrow keys on the keyboard. Pushing the sliders by using the mouse is less sensitive but even possible.

The Spectrum Analyzer now shows a plot like this:

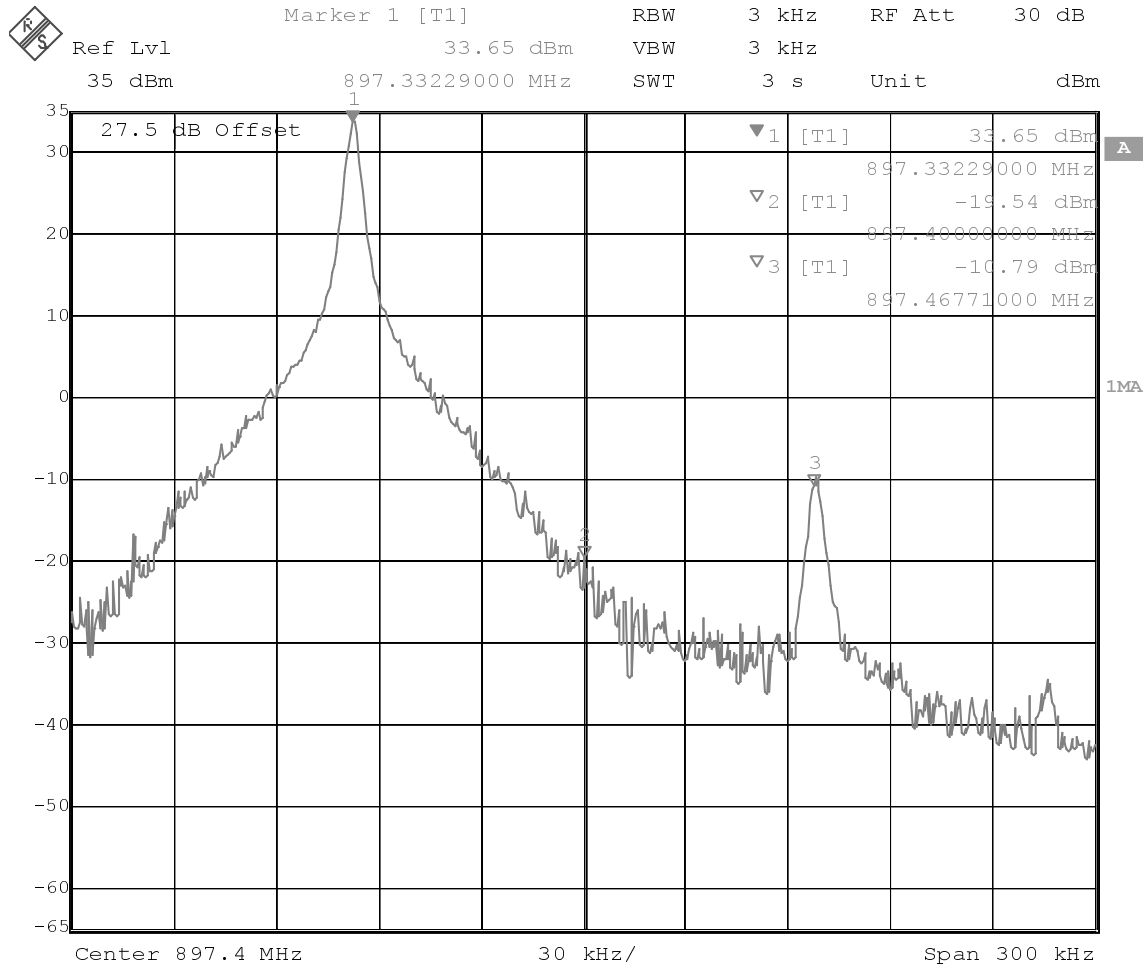

Date: 14.JAN.2002 13:20:36

Use the variables 'Amplitude difference' and 'Phase difference' to adjust the +67kHz signal to a minimum level (Marker 3). After tuning to the minimum the level difference between the peak levels at marker 1 and 3 must exceed 40dB. Tuning is possible by using arrow keys on the keyboard. Pushing the sliders by using the mouse is less sensitive but even possible.



The Spectrum Analyzer now shows a plot like this:

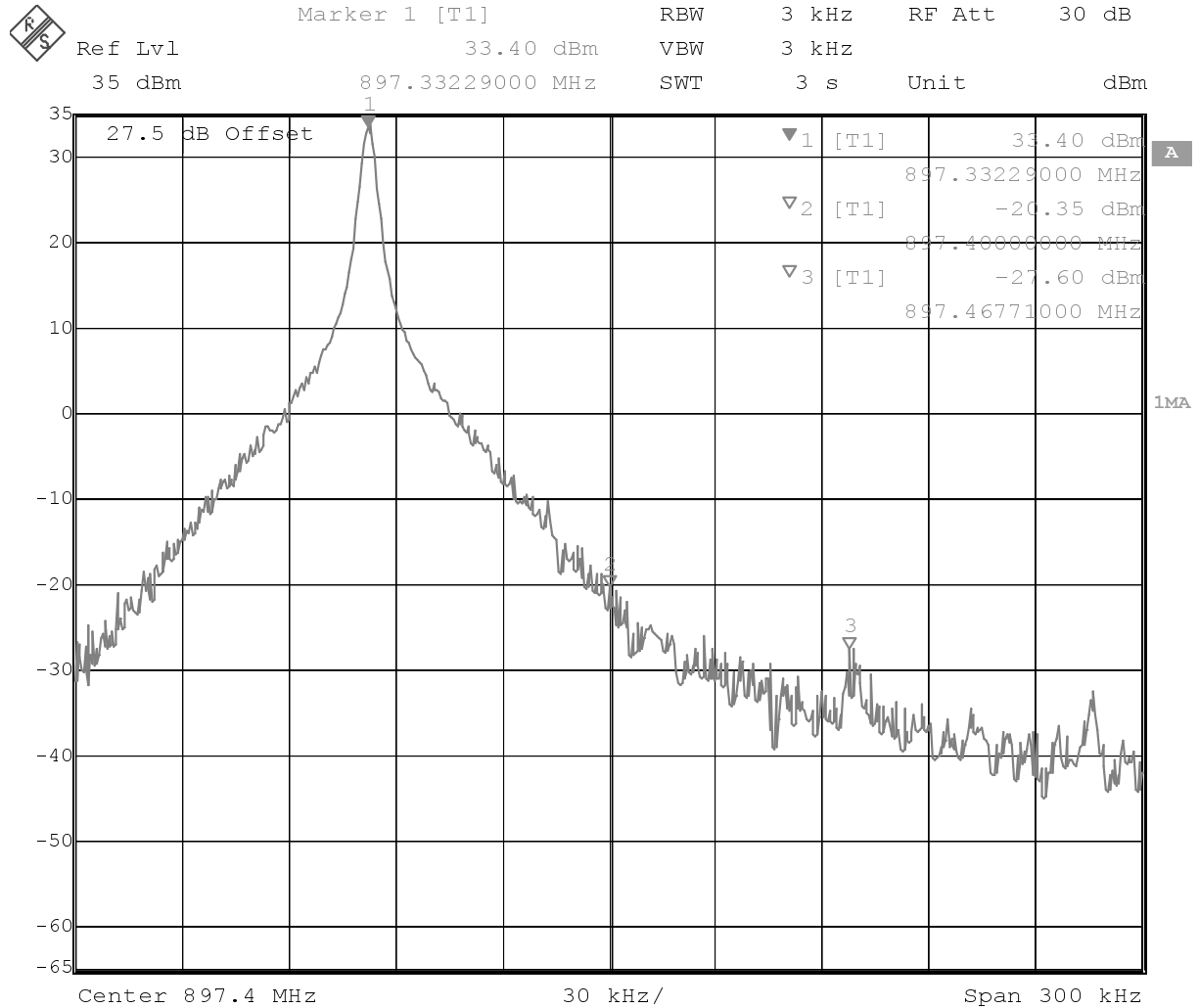

Date: 14.JAN.2002 13:23:02

Select again in the RF Controls Window:

Select "Save to Product"

Press Stop and the values are stored in the phone.

The EGSM TX IQ Tuning is now finished.

**Note:** The optimal values for "TX I and Q Offset" and "Amplitude and Phase Difference" vary from phone to phone.

**GSM1800 (DCS/PCN)**

**Caution:** In the case you use a spectrum analyser make sure that the external attenuation (20 - 30dB) between phone and spectrum analyser is high enough that the input of the analyser can't be destroyed. Adjust the reference level offset according to the insertion loss from the phone to the spectrum analyser .

**PC/Phone operation:**

Set operating mode to local mode

Select	RF	Alt-M
	Tuning	T
	TX IQ Tuning	I

Wait until the TX IQ Tuning window pops up.

Select	RF	Alt-M
	Tuning	T
	RF Controls	F

Wait until the RF Controls window pops up.

Connect a Spectrum Analyzer or GSM tester with the option \*Narrow Spectrum' to the RF connector of the phone.

If a spectrum analyzer is used then use the following settings.

	<b>GSM1800</b>
Center Frequency	1747.8MHz
Frequency Span	300 kHz
Resolution Bandwidth	3 kHz
Video Bandwidth	3 kHz
Sweep Time	3 sec.
Sweep Type	Clear/Write
Detector Type	Max Peak
Reference level	35 dBm
Marker 1	1747.73229 MHz
Marker 2	1747.8 MHz
Marker 3	1747.86771 MHz

Select in the RF Controls Window:

Select	Band	GSM 1800
	Active Unit	TX
	Operation Mode	Burst
	RX/TX Channel	700
	TX PA Mode	Free
	TX Data Type	All1

Select in the TX IQ Tuning Window:

Select "Load from Product"  
"Save to Product"

Press Start

Select again in the RF Controls Window:

Select TX Power Level 0

The setup should now look like this:

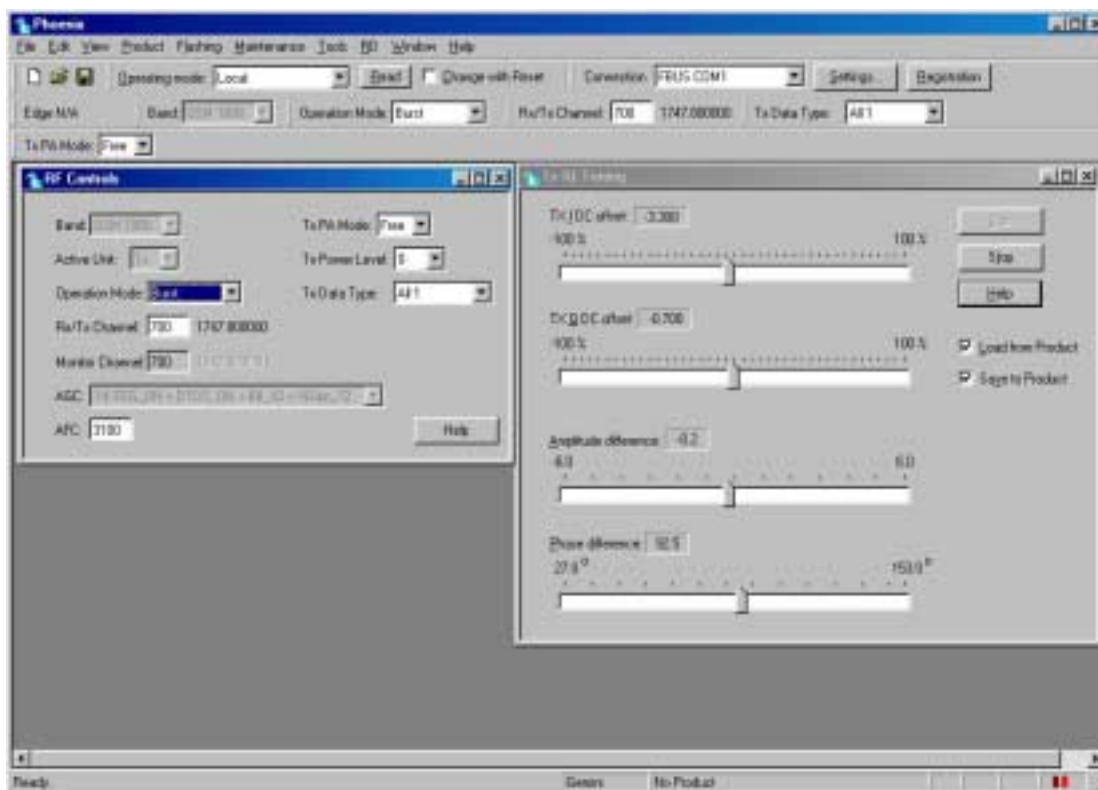

The Spectrum Analyzer now shows a plot like this:

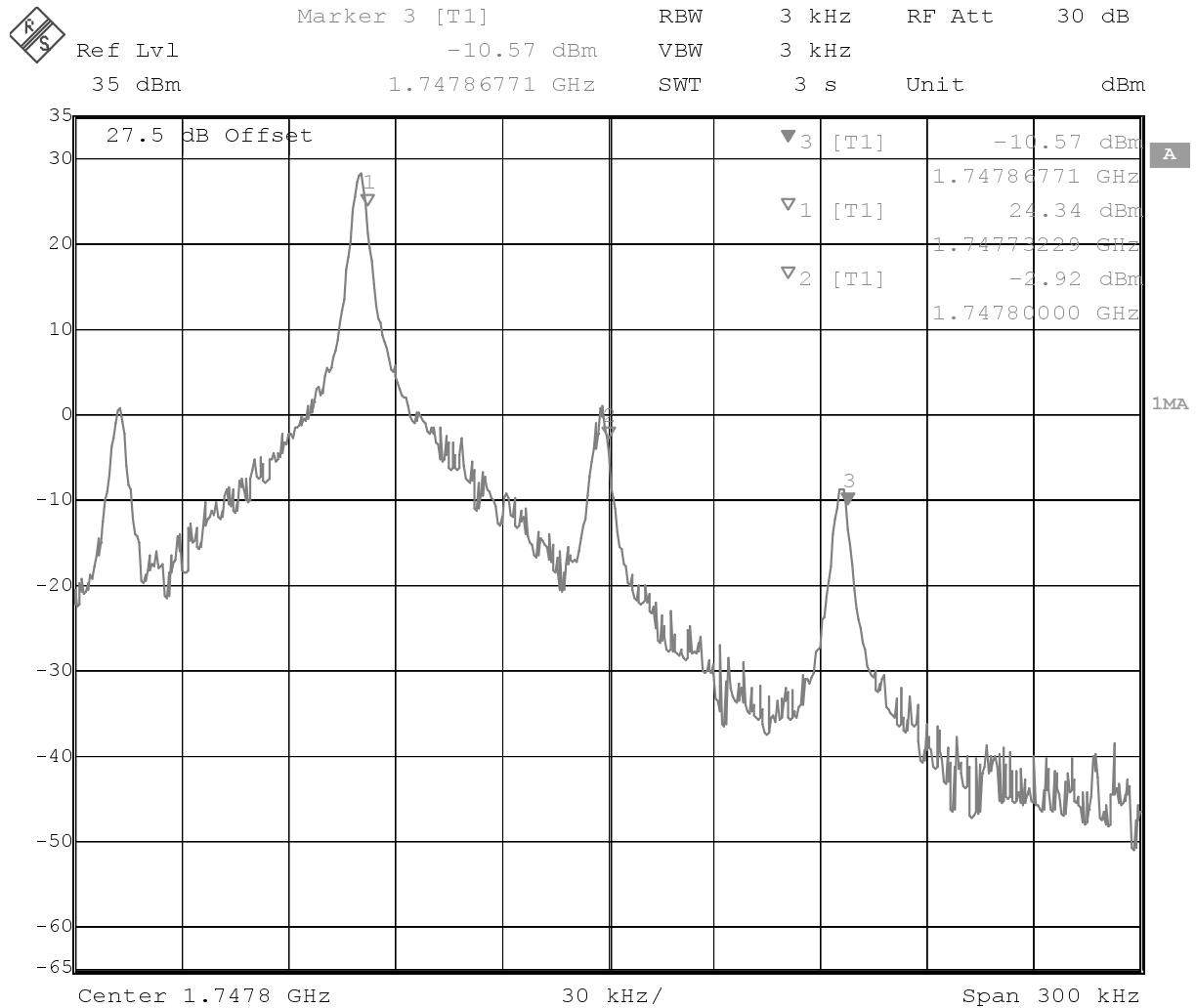

Date: 15.JAN.2002 10:18:02

The purpose of this tuning is to tune the carrier signal and the +67kHz signal to a minimum level (Marker 2 and 3).

Use the variables 'TX I DC offset' and 'TX Q DC offset' to adjust the carrier signal to a minimum level (Marker 2). After tuning to the minimum the level difference between the peak levels at marker 1 and 2 must exceed 40dB.

Tuning is possible by using arrow keys on the keyboard. Pushing the sliders by using the mouse is less sensitive but even possible.

The Spectrum Analyzer now shows a plot like this:

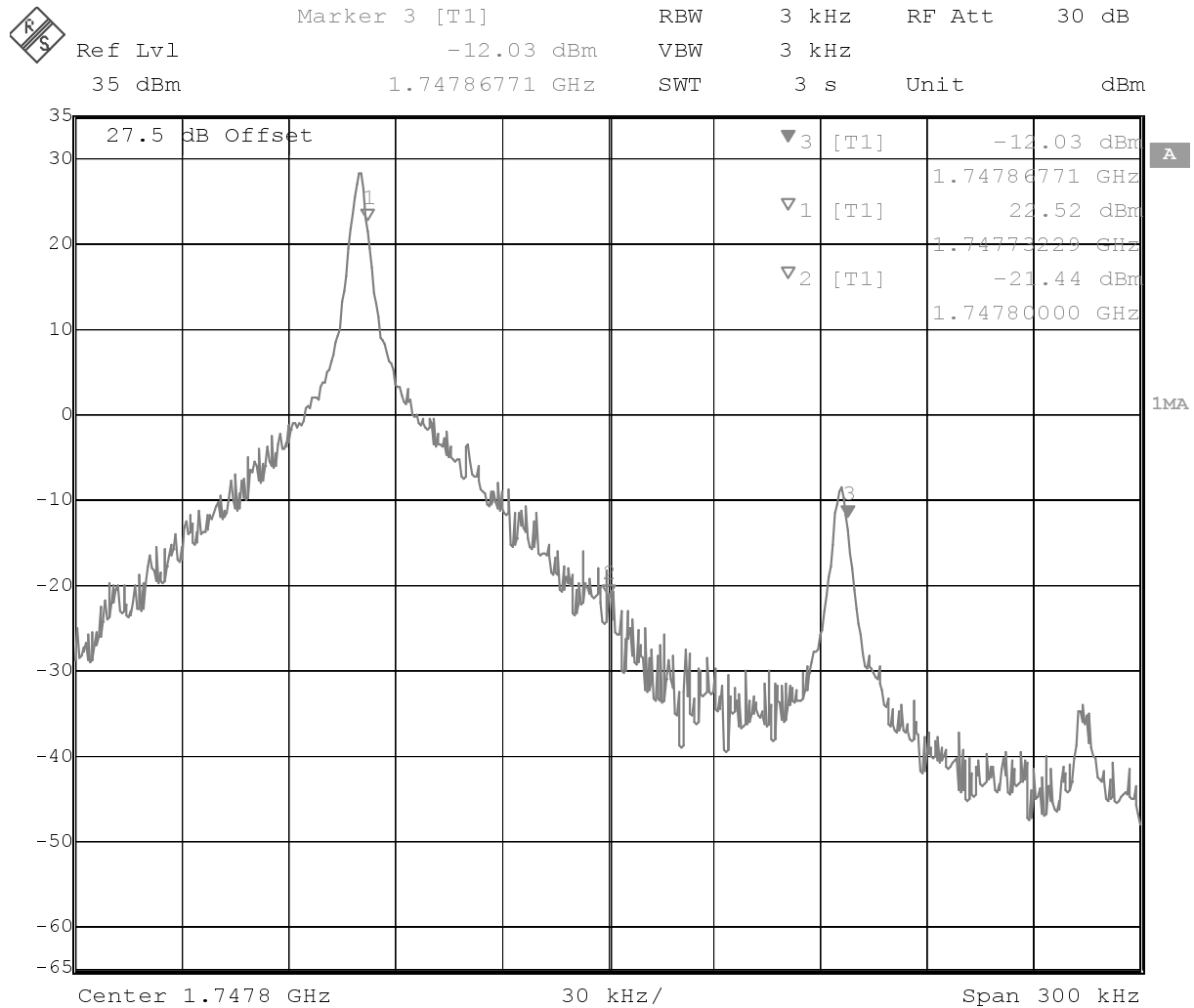

Date: 15.JAN.2002 10:20:39

Use the variables 'Amplitude difference' and 'Phase difference' to adjust the +67kHz signal to a minimum level (Marker 3)..After tuning to the minimum the level difference between the peak levels at marker 1 and 3 must exceed 40dB. Tuning is possible by using arrow keys on the keyboard. Pushing the sliders by using the mouse is less sensitive but even possible.

The Spectrum Analyzer now shows a plot like this:

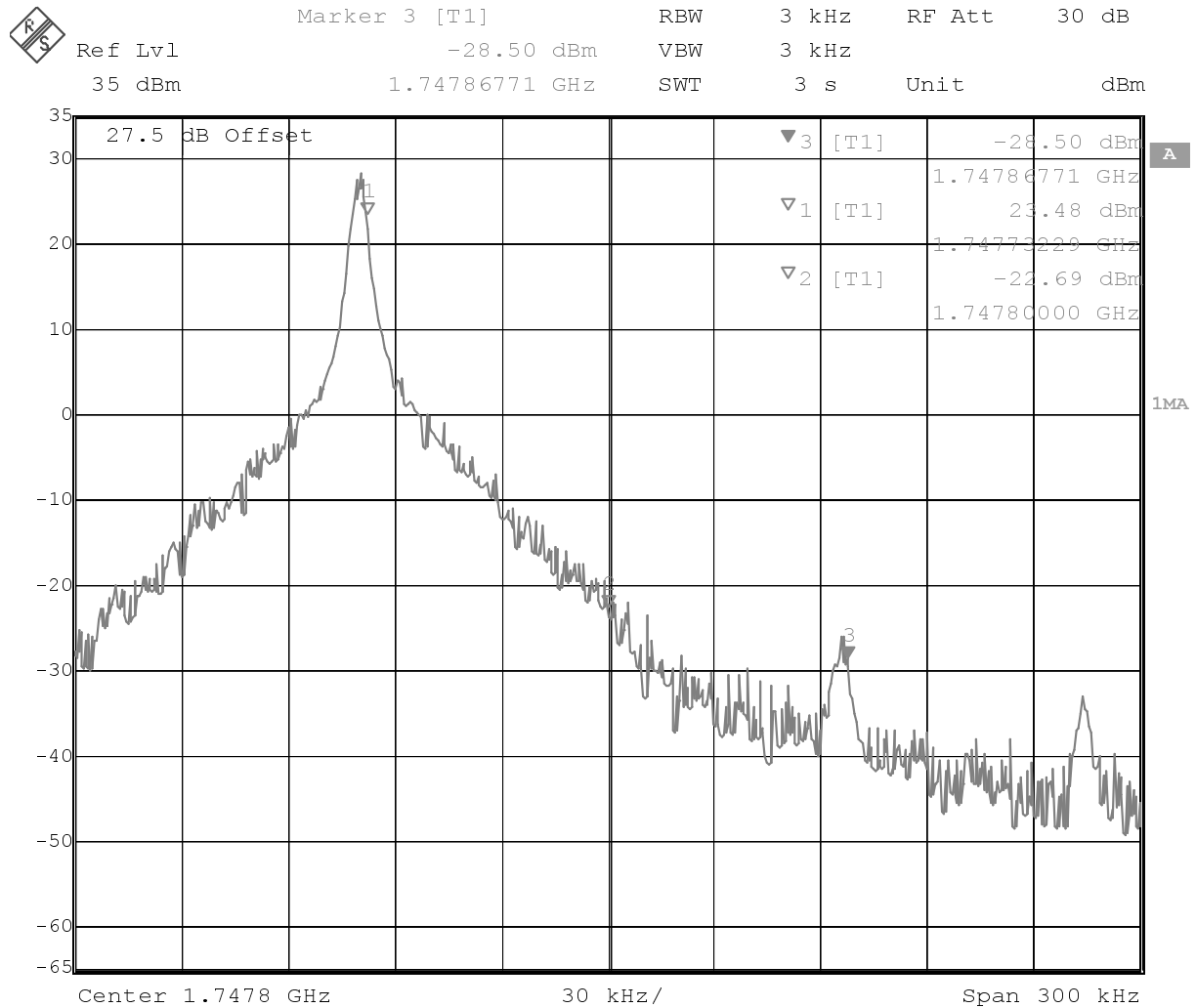

Date: 15.JAN.2002 10:22:02

Select 'Save to Product'

Press Stop in the TX IQ Tuning Window and the values are stored in the phone.

The GSM1800 TX IQ Tuning is now finished.

Note: The optimal values for "TX I and Q Offset" and "Amplitude and Phase Difference" vary from phone to phone.

### GSM1900 (PCS)

**Caution:** In case you use a spectrum analyser make sure that the external attenuation (20 - 30dB) between phone and spectrum analyser is high enough that the input of the analyser can't be destroyed. Adjust the reference level offset according to the insertion loss from the phone to the spectrum analyser .

PC/Phone operation:

Set operating mode to local mode



The setup should now look like this:

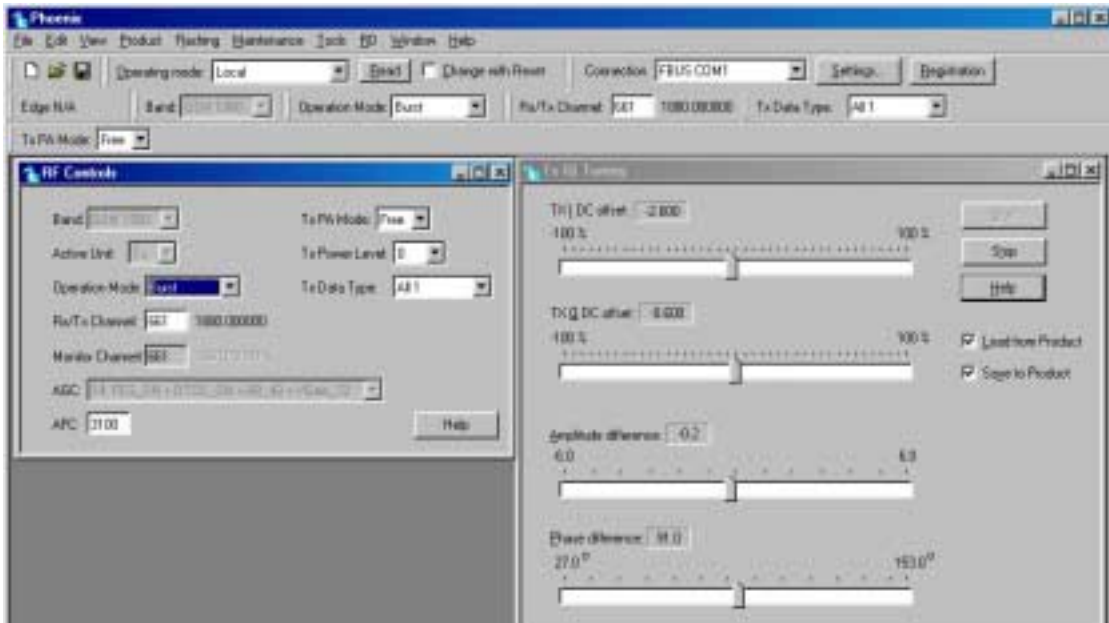

The Spectrum Analyzer now shows a plot like this:



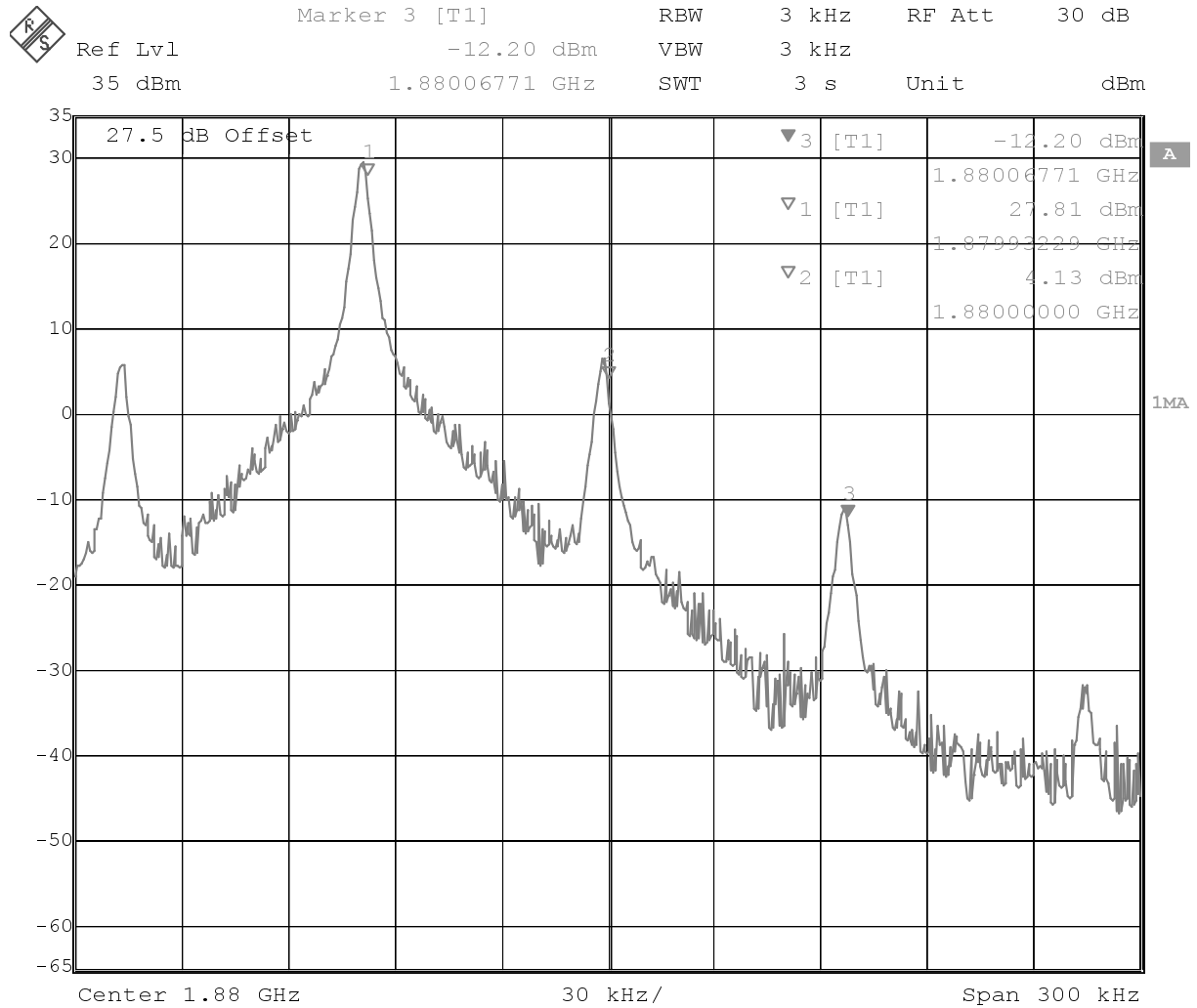

Date: 15.JAN.2002 10:53:47

The purpose of this tuning is to tune the carrier signal and the +67kHz signal to a minimum level (Marker 2 and 3).

Use the variables 'TX I DC offset' and 'TX Q DC offset' to adjust the carrier signal to a minimum level (Marker 2).

After tuning to the minimum the level difference between the peak levels at marker 1 and 2 must exceed 40dB.

Tuning is possible by using arrow keys on the keyboard. Pushing the sliders by using the mouse is less sensitive but even possible.

The Spectrum Analyzer now shows a plot like this:

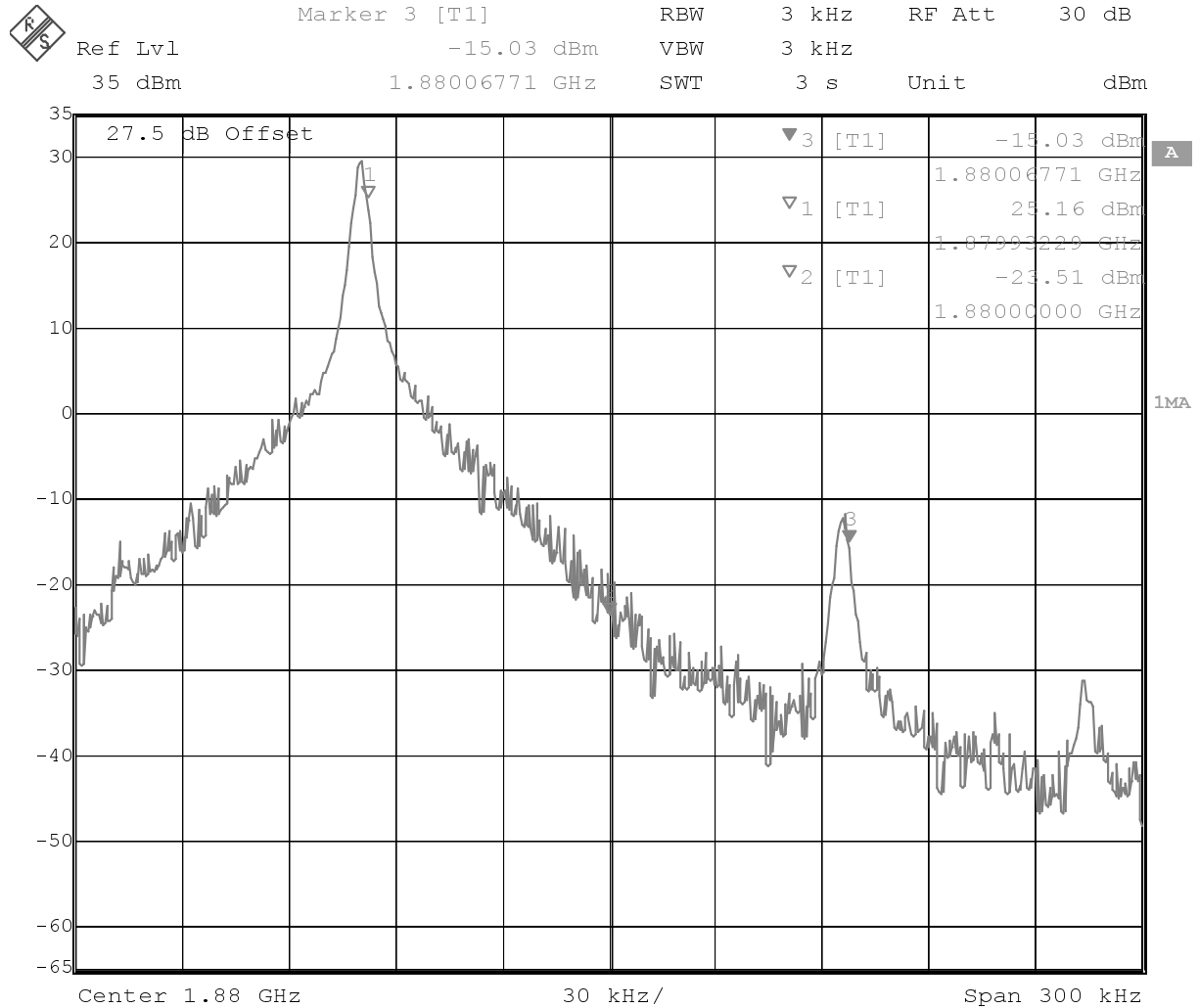

Date: 15.JAN.2002 10:57:06

Use the variables 'Amplitude difference' and Phase difference' to adjust the +67KHz signal to a minimum level (Marker 3). After tuning to the minimum the level difference between the peak levels at marker 1 and 3 must exceed 40dB, Tuning is possible by using arrow keys on the keyboard. Pushing the sliders by using the mouse is less sensitive but even possible'

The Spectrum Analyzer now shows a plot like this:

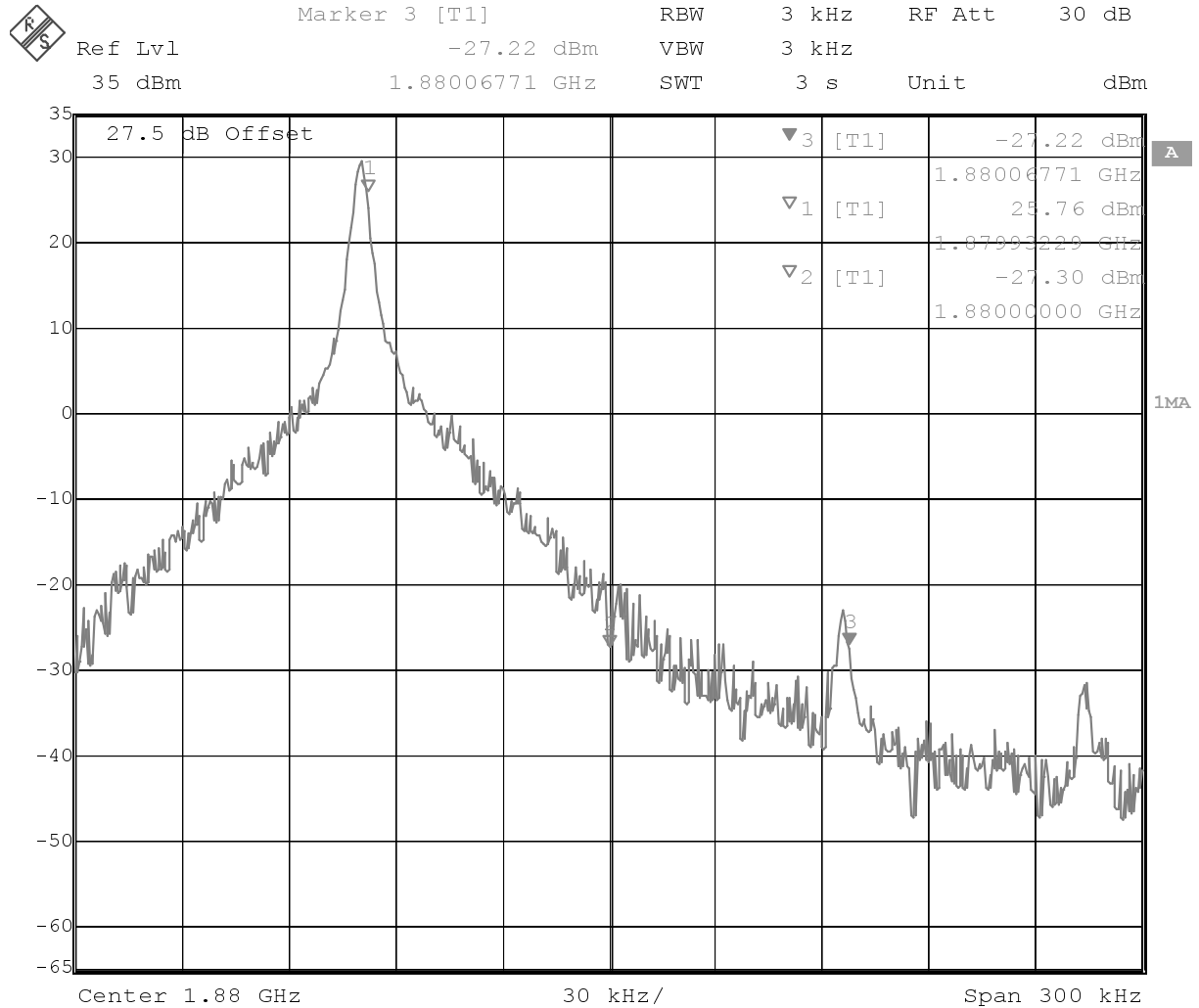

Date: 15.JAN.2002 10:58:09

Select 'Save to Product'

Press Stop in the TX IQ Tuning Window and the values are stored in the phone.

The GSM1900 TX IQ Tuning is now finished.

**Note:** The optimal values for "TX I and Q Offset" and "Amplitude and Phase Difference" vary from phone to phone.

**This page has been intentionally left blank**